

SHURE GUIDE TO
AUDIO SYSTEMS FOR
HOUSES OF WORSHIP



SHURE[®]
\$9.95

CONTENTS

Introduction:	4
Chapter 1: Sound	5
Chapter 2: The Sound Source	7
Chapter 3: The Sound System	8
What Is Good Sound?	9
Chapter 4: Microphones: Characteristics, Selection	11
Chapter 5: Microphones: Use	18
Interference Effects	20
Microphone Hookup	22
Chapter 6: Wireless Microphone Systems	26
Other Wireless Systems	31
Chapter 7: Automatic Microphone Systems and Signal Processors	33
Signal Processors: Equalizers and Feedback Control	34
Chapter 8: Typical Applications	37
Lectern	37
Altar	38
Handheld Vocal	39
Lavalier	40
Choir	40
Congregation	43
Musical Instruments	43
Non-Sanctuary Applications	45
Glossary:	47
Appendix One: The Decibel	50
Appendix Two: Potential Acoustic Gain	51
Appendix Three: Stereo Microphone Techniques	53
Conclusion:	54
Bibliography:	55
Biography:	56
Shure Product Selection Charts:	57

INTRODUCTION

Sound systems for houses of worship encompass a wide range of applications, from simple speech reinforcement in a fellowship hall to multi-channel live music performance in a large sanctuary with recording and broadcast capabilities. Though these systems may vary in size and complexity, they are all governed by the same physical principles and they share certain types of equipment.

Common components of these systems include microphones, mixers, amplifiers, loudspeakers, and many types of electronic signal processing devices such as equalizers, compressors, and audio time delays. A complete sound system involves some or all of these items. Proper selection and application of this equipment requires knowledge of both the overall system goals and the individual component characteristics.

The *scope* of this guide is limited primarily to the selection and application of microphones for worship facility sound systems. Since microphones act as the interface between the sound source and the sound system, it is necessary to include some discussion of these two areas, and sound in general, in order to understand how the microphone interacts with them. In addition, some related devices such as wireless microphones, automatic mixers and signal processors will be discussed.

The *objective* of this guide is to provide the reader with sufficient information to successfully select and apply microphones and related equipment for a variety of religious facility sound situations.

CHAPTER ONE

SOUND

Because good sound quality is the goal of any house of worship sound system, it is helpful to be familiar with some general aspects of sound: how it is produced, transmitted, and received. In addition, it is also useful to describe or classify sound according to its acoustic behavior. Finally, the characteristics of “good” sound should be understood.

Sound is **produced** by vibrating objects. These include musical instruments, loudspeakers, and, of course, human vocal cords. The mechanical vibrations of these objects move the air which is immediately adjacent to them, alternately “pushing” and “pulling” the air from its resting state. Each back-and-forth vibration produces a corresponding pressure increase (compression) and pressure decrease (rarefaction) in the air. A complete pressure change, or cycle, occurs when the air pressure goes from rest, to maximum, to minimum, and back to rest again. These cyclic pressure changes travel outward from the vibrating object, forming a pattern called a *sound wave*. A *sound wave* is a series of pressure changes (cycles) moving through the air.

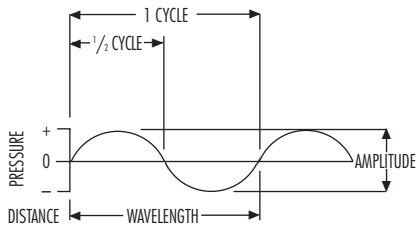

Schematic of Sound Wave

A simple sound wave can be described by its frequency and by its amplitude. The *frequency* of a sound wave is the rate at which the pressure changes occur. It is measured in Hertz (Hz), where 1 Hz is equal to 1 cycle-per-second. The range of frequencies audible to the human ear extends from a low of about 20 Hz to a high of about 20,000 Hz. In practice, a sound source such as a voice usually produces many frequencies simultaneously. In any such complex sound, the lowest frequency is called the fundamental and is responsible for the pitch of the sound. The higher frequencies are called harmonics and are responsible for the timbre or tone of the sound. Harmonics allow us to distinguish one source from another, such as a piano from a guitar, even when they are playing the same fundamental note. In the following chart, the solid section of each line indicates the range of fundamental frequencies, and the shaded section represents the range of the highest harmonics or overtones of the instrument.

The *amplitude* of a sound wave refers to the magnitude (strength) of the pressure changes and determines the “loudness” of the sound. Amplitude is measured in decibels (dB) of sound pressure level (SPL) and ranges from 0 dB SPL (the threshold of hearing), to above 120 dB SPL (the threshold of pain). The level of

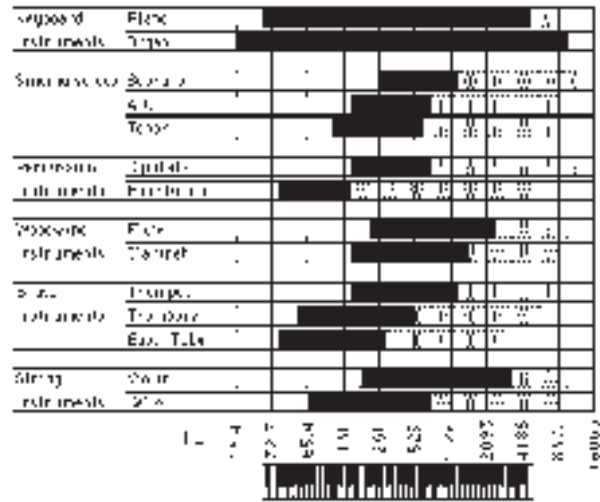

Instrument Frequency Ranges

conversational speech is about 70dB SPL. A change of 1 dB is about the smallest SPL difference that the human ear can detect, while 3 dB is a generally noticeable step, and an increase of 10 dB is perceived as a “doubling” of loudness. (See Appendix One: The Decibel.)

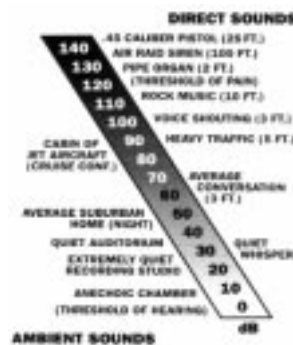

Sound Pressure Level of Typical Sources

Another characteristic of a sound wave related to frequency is *wavelength*. The wavelength of a sound wave is the physical distance from the start of one cycle to the start of the next cycle, as the wave moves through the air. Since each cycle is the same, the distance from any point in one cycle to the same point in the next cycle is also one wavelength: for example, the distance from one maximum pressure point to the next maximum pressure point.

Wavelength is related to frequency by the *speed of sound*. The speed of sound is the velocity at which a sound wave travels. The speed of sound is constant and is equal to about 1130 feet-per-second in air. It does not

Approximate wavelengths of common frequencies:

100 Hz: about 10 feet
1000 Hz: about 1 foot
10,000 Hz: about 1 inch

Wavelength Illustration Chart

SOUND

change with frequency or wavelength, but it is related to them in the following way: the frequency of a sound, multiplied by its wavelength always equals the speed of sound. Thus, the higher the frequency of sound, the shorter the wavelength, and the lower the frequency, the longer the wavelength. The wavelength of sound is responsible for many acoustic effects.

After it is produced, sound is **transmitted** through a “medium”. Air is the typical medium, but sound can also be transmitted through solid or liquid materials. Generally, a sound wave will move in a straight line unless it is absorbed or reflected by physical surfaces or objects in its path. However, the transmission of the sound wave will be affected only if the size of the surface or object is large compared to the wavelength of the sound. If the surface is small (compared to the wavelength) the sound will proceed as if the object were not there. High frequencies (short wavelengths) can be reflected or absorbed by small surfaces, but low frequencies (long wavelengths) can be reflected or absorbed only by very large surfaces or objects. For this reason it is easier to control high frequencies by acoustic means, while low frequency control requires massive (and expensive) techniques.

Once a sound has been produced and transmitted, it is **received** by the ear and, of course, by microphones. In the ear, the arriving pressure changes “push” and “pull” on the eardrum. The resulting motion of the eardrum is converted (by the inner ear) to nerve signals that are ultimately perceived as “sound”. In a microphone, the pressure changes act on a diaphragm. The resulting diaphragm motion is converted (by one of several mechanisms) into electrical signals which are sent to the sound system. For both “receivers”, the sound picked up is a combination of all pressure changes occurring just at the surface of the eardrum or diaphragm.

Sound can be classified by its acoustic behavior; for example, *direct* sound vs. *indirect* sound. Direct sound travels from the sound source to the listener in a straight line (the shortest path). Indirect sound is reflected by one or more surfaces before reaching the listener (a longer path). Since sound travels at a constant speed, it takes a longer time for the indirect sound to arrive, and it is said to be “delayed” relative to the direct sound. There are several kinds of indirect sound, depending on the “acoustic space” (room acoustics).

Echo occurs when an indirect sound is delayed long enough (by a distant reflecting surface) to be heard by the listener as a distinct repetition of the direct sound. If indirect sound is reflected many times from different surfaces it becomes “diffuse” or non-directional. This is

called *reverberation*, and it is responsible for our auditory perception of the size of a room. Reverberant sound is a major component of ambient sound, which may include other non-directional sounds, such as wind noise or building vibrations. A certain amount of reverberant sound is desirable to add a sense of “space” to the sound, but an excess tends to make the sound muddy and unintelligible.

One additional form of indirect sound is known as a *standing wave*. This may occur when the wavelength of a sound is the same dimension of a room, such as the distance between two

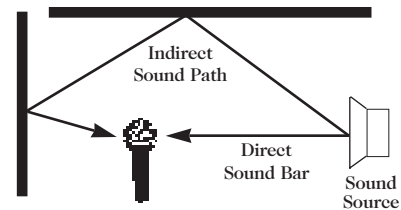

Direct vs. Indirect Sound

opposite walls. If both surfaces are acoustically reflective, the frequency corresponding to that wavelength will be amplified, by addition of the incoming and outgoing waves, resulting in a strong, stationary wave pattern between the two surfaces. This happens primarily with low frequencies, which have long wavelengths and are not easily absorbed.

A very important property of direct sound is that it becomes weaker as it travels away from the sound source, at a rate governed by the *inverse-square law*.

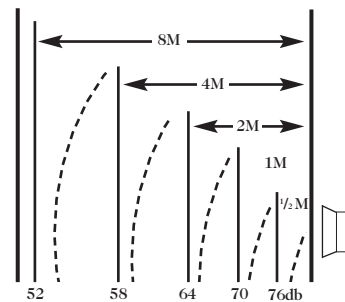

Inverse Square Law

For example, when the distance increases by a factor of two (doubles), the sound level decreases by a factor of four (the square of two). This results in a drop of 6 dB in sound pressure level (SPL), a substantial decrease. Likewise, when the distance to the direct sound source is divided by two (cut in half), the sound level *increases* by 6 dB. In contrast, ambient sound, such as reverberation, has a relatively constant level. Therefore, at a given distance from a sound source, a listener (or a microphone) will pick up a certain proportion of direct sound vs. ambient sound.

As the distance increases, the direct sound level decreases while the ambient sound level stays the same. A properly designed sound system should increase the amount of direct sound reaching the listener without increasing the ambient sound significantly.

THE SOUND SOURCE

The *sound sources* most often found in worship facility applications are the speaking voice, the singing voice, and a variety of musical instruments. Voices may be male or female, loud or soft, single or multiple, close or distant, etc. Instruments may range from a simple acoustic guitar to a pipe organ or even to a full orchestra. Pre-recorded accompaniment is also very common.

In addition to these desired sound sources there are certain undesired sound sources that may be present: building noise from air conditioning or buzzing light fixtures, noise from the congregation, sounds from street or air traffic, etc. Even some desired sounds may become a problem, such as an organ that overpowers the choir.

In this context, the loudspeakers of the sound system must also be considered a sound source. They are a “desired” sound source for the congregation, but they can become an undesired source for microphone pickup: *feedback* (an annoying howl or ringing sound) can occur in a sound system if microphones “hear” too much of the loudspeakers.

The *acoustics* of the room are often as important as the sound source itself. Room acoustics are a function of the size and shape of the room, the materials covering the interior surfaces, and even the presence of the congregation. The acoustic nature of an area may have a positive or a negative effect on the sound produced by voices, instruments, and loudspeakers before it is picked up by microphones or heard by listeners: absorbing or diminishing some sounds while reflecting or reinforcing other sounds. Strong reflections can contribute to undesired sound in the form of echo, standing waves, or excessive reverberation.

Thus, sound sources may be categorized as desired or undesired, and the sound produced by them may be further classified as being direct or indirect. In practice, the *soundfield* or total sound in a space will always consist of both direct and indirect sound, except in anechoic chambers or, to some extent, outdoors, when there are no nearby reflective surfaces.

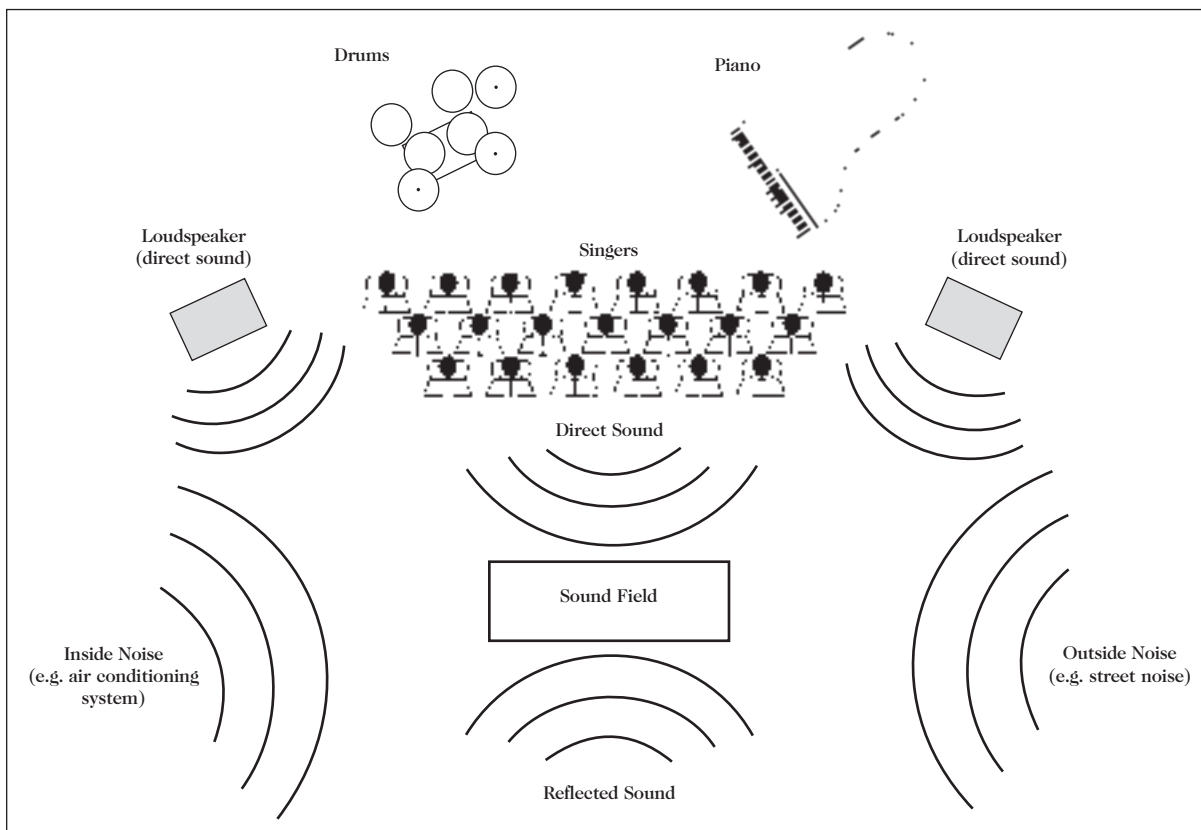

Sound Sources and Sound Field

THE SOUND SYSTEM

A basic sound reinforcement system consists of an *input device* (microphone), a *control device* (mixer), an *amplification device* (power amplifier), and an *output device* (loudspeaker). This arrangement of components is sometimes referred to as the audio chain: each device is linked to the next in a specific order. The primary goal of the sound system in house of worship sound applications is to deliver clear, intelligible speech, and, usually, high-quality musical sound, to the entire congregation. The overall design, and each component of it, must be intelligently thought out, carefully installed, and properly operated to accomplish this goal.

Electronic signal processors, such as equalizers, limiters or time delays, are inserted into the audio chain, usually between the mixer and the power amplifier, or often within the mixer itself. They operate at line level. The general function of these processors is to enhance the sound in some way or to compensate for certain deficiencies in the sound sources or in the room acoustics.

In addition to feeding loudspeakers, an output of the system may be sent simultaneously to recording devices or even used for broadcast. It is also possible to deliver sound to multiple rooms, such as vestibules and cry rooms, by using additional power amplifiers and loudspeakers.

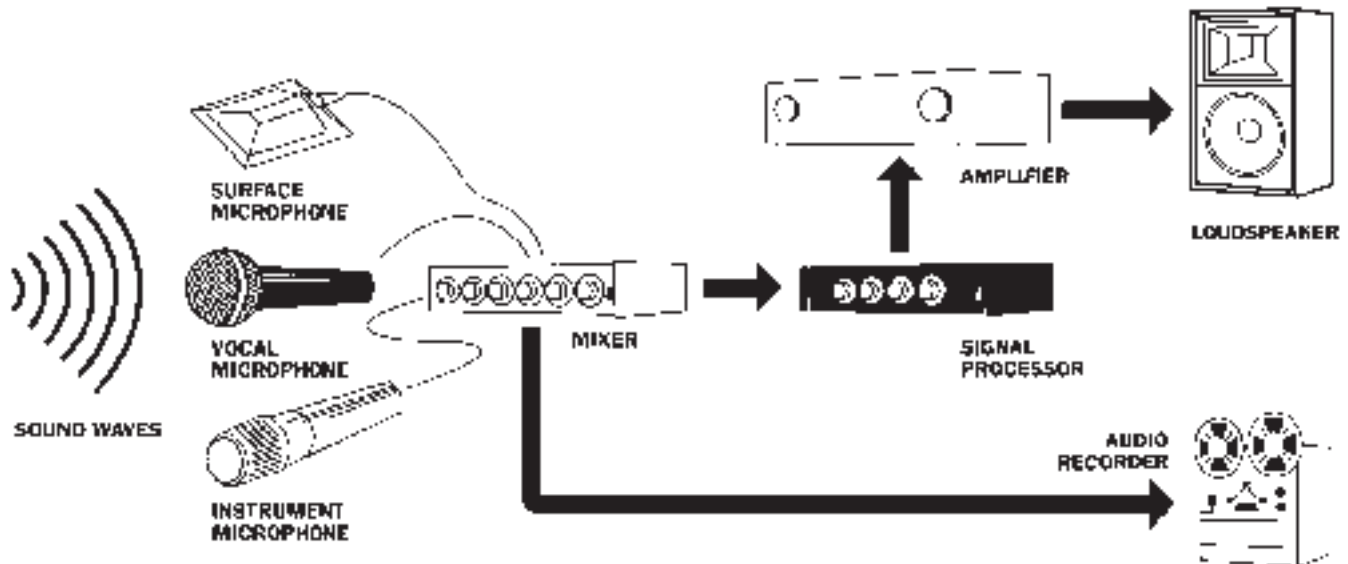

Typical Sound System

There are three levels of electrical signals in a sound system: microphone level (a few thousandths of a Volt), line level (approximately one Volt), and speaker level (ten Volts or higher). See Appendix One: The Decibel.

Sound is picked up and converted into an electrical signal by the microphone. This microphone level signal is amplified to line level and possibly combined with signals from other microphones by the mixer. The power amplifier then boosts the line level signal to speaker level to drive the loudspeakers, which convert the electrical signal back into sound.

Finally, it may be useful to consider the room acoustics as part of the sound system: acoustics act as a “signal processor” that affects sound both before it is picked up by the microphone and after it is produced by the loudspeakers. Good acoustics may enhance the sound, while poor acoustics may degrade it, sometimes beyond the corrective capabilities of the equipment. In any case, the role of room acoustics in sound system performance cannot be ignored.

THE SOUND SYSTEM

What is “good” sound?

The three primary measures of sound quality are fidelity, intelligibility, and loudness. In a house of worship the quality of sound will depend on the quality of the sound sources, the sound system, and the room acoustics. Typically, our references for sound quality are high fidelity music systems, broadcast television and radio, motion picture theaters, concerts, plays, and everyday conversation. To the extent that the quality of many of these references has improved dramatically over time, our expectations of the sound quality in worship facilities has also increased.

The **fidelity** of sound is primarily determined by the overall *frequency response* of the sound arriving at the listener’s ear. It must have sufficient frequency range and uniformity to produce realistic and accurate speech and music. All parts of the audio chain contribute to this: a limitation in any individual component will limit the fidelity of the entire system. Frequency range of the human voice is about 100-12kHz, while a compact disc has a range of 20-20kHz. A telephone has a frequency range of about 300-3kHz and though this may be adequate for conversational speech, it would certainly be unacceptable for a sound system. However, even a high fidelity source reproduced through a high fidelity sound system may suffer due to room acoustics that cause severe frequency imbalances such as standing waves.

The **intelligibility** of sound is determined by the overall *signal-to-noise* ratio and the *direct-to-reverberant* sound ratio at the listener’s ear. In a house of worship, the primary “signal” is the spoken word. The “noise” is the ambient noise in the room as well as any electrical noise added by the sound system. In order to understand speech with maximum intelligibility and minimum effort, the speech level should be at least 20dB louder than the noise at every listener’s ear. The sound that comes from the system loudspeakers already has a signal-to-noise ratio limited by the speech-to-noise ratio at the microphone. To insure that the final speech-to-noise ratio at the listener is at least 20dB, the speech-to-noise ratio at the microphone must be at least 30dB. That is, the level of the voice picked up by the microphone must be at least 30dB louder than the ambient noise picked up by the microphone.

The direct-to-reverberant ratio is determined by the directivity of the system loudspeakers and the acoustic reverberation characteristic of the room. *Reverberation time* is the length of time that a sound persists in a room even after the sound source has stopped. A high level of reverberant sound interferes with intelligibility by making it difficult to distinguish the end of one word from the start of the next. A reverberation time of 1 second or less is ideal for speech intelligibility. However, such rooms tend to sound somewhat lifeless for music, especially traditional choral or orchestral music. Reverberation times of 3-4 seconds or longer are preferred for those sources.

Reverberation can be reduced only by absorptive acoustic treatment. If it is not possible to absorb the reverberant sound once it is created, then it is necessary either to increase the level of the direct sound, to decrease the creation of reverberant sound, or a combination of the two. Simply raising the level of the sound system will raise the reverberation level as well. However, use of directional loudspeakers allows the sound to be more precisely “aimed” toward the listener and away from walls and other reflective surfaces that contribute to reverberation. Again, directional control is more easily achieved at high frequencies than at low frequencies.

Finally, the **loudness** of the speech or music at the furthest listener must be sufficient to achieve the required effect: comfortable levels for speech, perhaps more powerful levels for certain types of music. These levels should be attainable without distortion or feedback. The loudness is determined by the dynamic range of the sound system, the potential acoustic gain (PAG) of the system, and the room acoustics. The *dynamic range* of a sound system is the difference in level between the noise floor of the system and the loudest sound level that it can produce without distortion. It is ultimately limited only by the available amplifier power and loudspeaker efficiency. The loudness requirement dictates the *needed acoustic gain* (NAG) so that the furthest listener can hear at a level similar to closer listeners. It is relatively easy to design a playback-only system with adequate dynamic range based only on NAG and component specifications. However, a sound reinforcement system with microphones requires consideration of *potential acoustic gain*.

THE SOUND SYSTEM

Potential Acoustic Gain (PAG) is a measure of how much gain or amplification a sound system will provide before feedback occurs. This turns out to be much more difficult than designing for dynamic range because it depends very little on the type of system components but very much on the relative locations of microphones, loudspeakers, talkers, and listeners. (See Appendix Two: Potential Acoustic Gain.)

Room acoustics also play a role in loudness. Specifically, reverberant sound adds to the level of the overall sound-field indoors. If reverberation is moderate, the loudness will be somewhat increased without ill effect. If reverberation is excessive, the loudness may substantially increase but with potential loss of fidelity and intelligibility.

Although “good” sound is qualitatively determined by the ear of the beholder, there are quantitative design methods and measurements that can be used to accurately predict and evaluate performance. It is usually possible (though often not easy) to resolve the competing factors of acoustics, sound systems, architecture, aesthetics and budget in order to deliver good sound in a house of worship. However, major deficiencies in any of these areas can seriously compromise the final result. Readers who are contemplating major sound system purchases, acoustic changes, or new construction are encouraged to speak with knowledgeable consultants and/or experienced contractors to ensure the “best” sound.

CHAPTER FOUR

MICROPHONES:
CHARACTERISTICS, SELECTION

The microphone is the first link in the audio chain and is therefore critical to the overall performance of a sound system. Improper selection of microphones may prevent the rest of the system from functioning to its full potential. Proper selection of microphones depends on an understanding of basic microphone characteristics and on a knowledge of the intended application.

To be most effective, a microphone must be matched both to the desired sound source (voice, musical instrument, etc.) and to the sound system (PA system, tape recorder, etc.) with which it is used. There are five areas of microphone characteristics that must be considered when selecting a microphone for a particular application. They are: 1) the operating principle of the microphone, 2) the frequency response of the microphone, 3) the directionality of the microphone, 4) the electrical output of the microphone, and 5) the physical design of the microphone.

1) Operating Principle: How does the microphone change sound into an electrical signal?

The operating principle describes the type of *transducer* inside the microphone. A transducer is a device that changes energy from one form into another, in this case, acoustic energy into electrical energy. It is the part of the microphone that actually picks up sound and converts it into an electrical signal. The operating principle determines some of the basic capabilities of the microphone.

The two most common types are *dynamic* and *condenser*. Although there are other operating principles used in microphones (such as ribbon, crystal, carbon, etc.) these are used primarily in communications systems or are of historical interest only. They are rarely encountered in worship facility sound applications.

Dynamic microphones employ a diaphragm/voice coil/magnet assembly which forms a miniature sound-driven electrical generator. Sound waves strike a thin plastic membrane (diaphragm) which vibrates in response. A small coil of wire (voice coil) is attached to the rear of the diaphragm and vibrates with it. The voice coil itself is surrounded by a magnetic field created by a small permanent magnet. It is the motion of the voice coil in this magnetic field which generates the electrical signal corresponding to the sound picked up by a dynamic microphone.

Dynamic microphones have relatively simple construction and are therefore economical and rugged. They can provide excellent sound quality and good specifications in all areas of microphone performance. In particular, they can handle extremely high sound levels: it is almost impossible to overload a dynamic microphone. Dynamics are the type most widely used in general sound reinforcement and have many applications in worship facility sound systems.

Condenser microphones are based on an electrically-charged diaphragm/backplate assembly which forms a sound-sensitive capacitor. Here, sound waves vibrate a very thin metal or metal-coated-plastic diaphragm. The diaphragm is mounted just in front of a rigid "backplate" (metal or metal-coated ceramic). In electrical terms, this assembly or element is known as a capacitor (historically called a "condenser"), which has the ability to store a charge or voltage. When the element is charged, an electric field is created between the diaphragm and the backplate, proportional to the spacing between them. It is the variation of this spacing, due to the motion of the diaphragm relative to the backplate, that produces the electrical signal corresponding to the sound picked up by a condenser microphone.

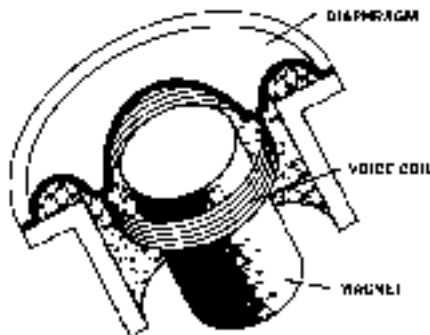

Dynamic Microphone

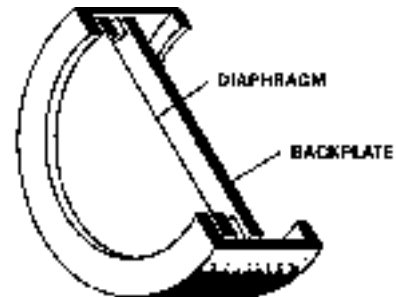

Condenser Microphone

CHAPTER FOUR

MICROPHONES:
CHARACTERISTICS, SELECTION

The construction of a condenser microphone must include some provision for maintaining the electrical charge. An “electret” condenser microphone has a permanent charge, maintained by a special material such as Teflon™ deposited on the backplate or on the diaphragm. Other types are charged by means of an external power source.

All condenser microphones contain additional circuitry to match the electrical output of the element to typical microphone inputs. This requires that all condenser microphones be powered: either by batteries or by “phantom” power (a method of supplying power to a microphone through the microphone cable itself). There are two potential limitations of condenser microphones due to the additional circuitry: first, the electronics produce a small amount of noise; second, there is a limit to the maximum signal level that the electronics can handle. Good designs, however, have very low noise levels and are also capable of very wide dynamic range.

Condenser microphones are more complex than dynamics and tend to be somewhat more costly. However, condensers can readily be made with higher sensitivity and can provide a smoother, more natural sound, particularly at high frequencies. Flat frequency response and extended frequency range are much easier to obtain in a condenser. In addition, condenser microphones can be made very small without significant loss of performance.

The decision to use a condenser or dynamic microphone depends not only on the sound source and the signal destination but on the physical setting as well. From a practical standpoint, if the microphone will be used in a severe environment such as a fellowship hall or for outdoor sound, a dynamic microphone would be a good choice. In a more controlled environment, for example, in a sanctuary, auditorium, or theatrical setting, a condenser microphone might be preferred for some sound sources, especially when the highest sound quality is desired.

2) Frequency Response: How does the microphone sound?

The frequency response of a microphone is defined by the range of sound (from lowest to highest frequency) that it can reproduce, and by its variation in output within that range. It is the frequency response that determines the basic “sound” of the microphone.

The two general types of frequency response are *flat* and *shaped*. These terms refer to the graphical representation of frequency response or response curve.

A microphone that provides a uniform output at every audible frequency is represented on a frequency response graph as an even, flat line, and is said to have a *flat* response. This means that the microphone reproduces all of the sound within its frequency range with little or no variation from the original sound. In addition, flat response microphones typically have an extended frequency range; that is, they can reproduce very high and/or very low frequencies as well. Wide-range, flat response microphones have a natural, high-fidelity, “uncolored” sound.

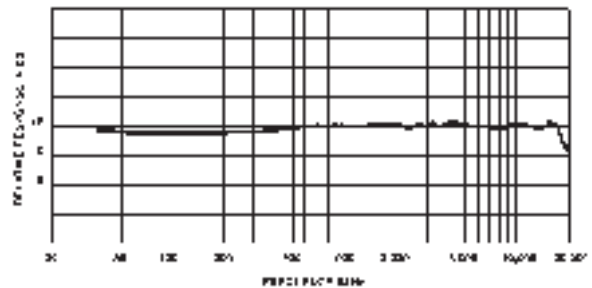

Flat Frequency Response

By contrast, a *shaped* microphone response will appear on a frequency response graph as a varying line with specific peaks and dips. This shows that the microphone is more sensitive to certain frequencies than to others, and often has a limited frequency range. A shaped response is usually designed to enhance the sound of a particular source in a particular application, while at the same time minimizing the pickup of certain unwanted sounds. Shaped response microphones each have a “characteristic” sound.

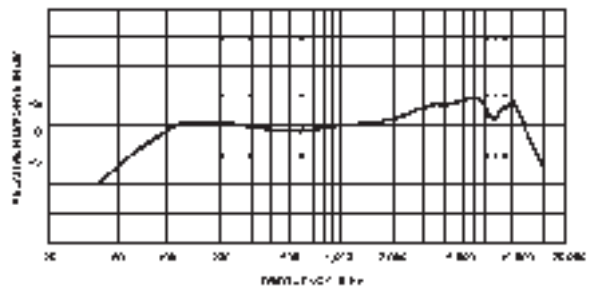

Shaped Frequency Response

CHAPTER FOUR

MICROPHONES:
CHARACTERISTICS, SELECTION

The selection of a flat or shaped response microphone involves consideration of both the sound source and the sound destination. The frequency range of the microphone must be wide enough to pick up the desired range of the sound source. This range must also be appropriate to the intended destination of the sound: that is, wider range for high-quality sound systems or recording/broadcast systems, narrower range for speech-only public address systems.

Within its range the microphone should respond in such a way that the sound is reproduced either with no change (flat response) or with changes that enhance the sound in some desirable manner (shaped response). Normally, microphones with flat, wide-range response are recommended for high-quality pickup of acoustic instruments, choral groups and orchestras, especially when they must be placed at some distance from the sound source. Flat response microphones are less prone to feedback in high gain, distant pickup applications because they do not have frequency response peaks that might trigger feedback at any specific frequency.

The most common shaped response is for vocal use. Typically, this consists of limiting the range to that of the human voice and adding an upper mid-range response rise. Such a “presence rise”, coupled with controlled low- and high-frequency response can give a sound with improved vocal clarity. This is especially true for lapel or lavalier microphones. The pickup of certain instruments such as drums and guitar amplifiers may also benefit from a shaped response microphone.

Finally, the frequency response of some microphones is adjustable, typically by means of switches, to tailor the

microphone to different applications. Most common are low-frequency rolloff controls, which can help prevent “rumble”, and presence rise switches to enhance intelligibility.

3) Directionality: How does the microphone respond to sound from different directions?

The directional characteristic of a microphone is defined as the variation of its output when it is oriented at different angles to the direction of the sound. It determines how best to place the microphone relative to the sound source(s) in order to enhance pickup of desired sound and to minimize pickup of undesired sound. The *polar pattern* of a microphone is the graphical representation of its directionality. The two most common directional types are *omnidirectional* and *unidirectional*.

A microphone that exhibits the same output regardless of its orientation to the sound source will show on a polar graph as a smooth circle and is said to have an *omnidirectional* pattern. This indicates that the microphone is equally sensitive to sound coming from all directions. An omnidirectional microphone can therefore pick up sound from a wide area, but cannot be “aimed” to favor one sound over another.

A *unidirectional* microphone, on the other hand, is most sensitive to sound coming from only one direction. On a polar graph, this will appear as a rounded but non-circular figure. The most common type of unidirectional microphone is called a *cardioid*, because of its heart-shaped polar pattern.

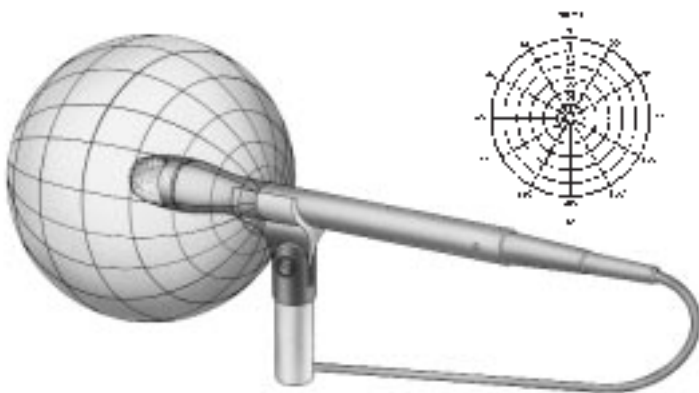

Omnidirectional Microphone

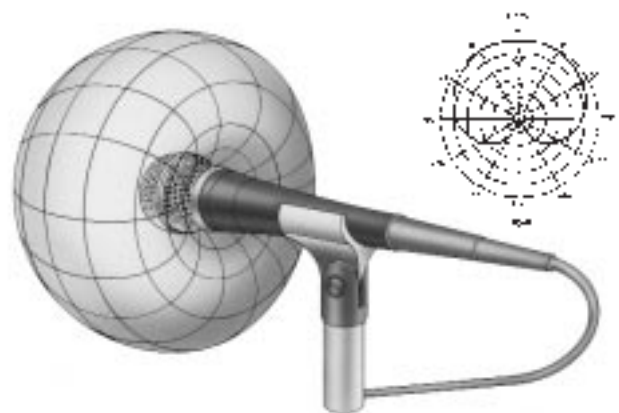

Cardioid (Unidirectional) Microphone

CHAPTER FOUR

MICROPHONES:
CHARACTERISTICS, SELECTION

A cardioid type is most sensitive to sound coming from in front of the microphone (the bottom of the "heart"). On the polar graph this is at 0 degrees, or "on-axis". It is less sensitive to sound reaching the microphone from the sides ("off-axis"), and the direction of least sensitivity is toward the rear (the notch at the top of the "heart"). For any microphone, the direction of least sensitivity (minimum output) is called the *null angle*. For a cardioid pattern, this is at 180 degrees or directly behind the microphone.

Thus, a unidirectional microphone may be aimed at a desired, direct sound by orienting its axis toward the sound. It may also be aimed away from an undesired, direct sound by orienting its null angle toward the sound. In addition, a unidirectional microphone picks up less ambient sound than an omnidirectional, due to its overall lower sensitivity at the sides and rear. For example, a cardioid picks up only one-third as much ambient sound as an omnidirectional type.

Although the output of a unidirectional microphone is maximum for sound arriving at an angle of 0 degrees, or on-axis, it falls off only slightly for sound arriving from within a certain angle off-axis. The total directional range for usable output is called the *coverage angle* or *pickup arc*: for a cardioid microphone this is about 130 degrees.

Two related types of unidirectional microphones are the *supercardioid* and the *hypercardioid*. Compared to a cardioid type, these have a progressively narrower coverage angle: 115 degrees for a supercardioid and 105 degrees for a hypercardioid. However, unlike the cardioid, they have some pickup directly behind the microphone. This is indicated in their polar patterns by a

rounded projection, called a *lobe*, toward the rear of the microphone. The direction of least sensitivity (null angle) for these types is about 125 degrees for the supercardioid and 110 degrees for the hypercardioid. In general, any directional pattern that has a narrower front coverage angle than a cardioid will have some rear pickup and a different null angle.

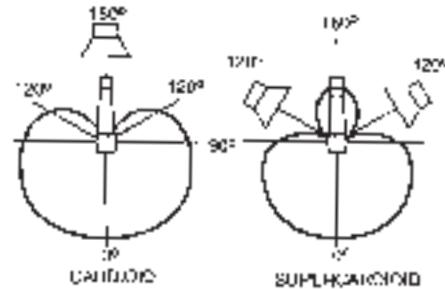

*Monitor Speaker Placement For Maximum Rejection:
Cardioid and Supercardioid*

The significance of these two polar patterns is their greater rejection of ambient sound in favor of on-axis sound: the supercardioid has the maximum ratio of on-axis pickup to ambient pickup, while the hypercardioid has the least overall pickup of ambient sound (only one-quarter as much as an omni). These can be useful types for certain situations, such as more distant pickup or in higher ambient noise levels, but they must be placed more carefully than a cardioid to get best performance.

Other types of unidirectional microphones include "shotgun" and parabolic reflector models. The shotgun has an extremely narrow pickup pattern and is used in very high ambient noise situations. However, its limited off-axis sound quality makes it unsuitable for typical religious facility sound reinforcement. It is most often used in broadcast and film production.

The parabolic type actually employs an omnidirectional microphone placed at the focal point of a parabolic reflector. Like a reflecting telescope, most of the energy (sound) striking the reflector is concentrated at the focal point. This effectively amplifies the sound from a distant source. However, poor low frequency response, uneven off-axis response, and its large size make it also unsuitable for sound reinforcement. Again, it is used primarily in broadcast applications such as sporting events.

One additional directional microphone is the *bidirectional* type. As the name implies, it is equally sensitive to sound from two directions: directly in front of the microphone and directly behind it. Its polar graph consists of a front pickup area and an identical rear lobe,

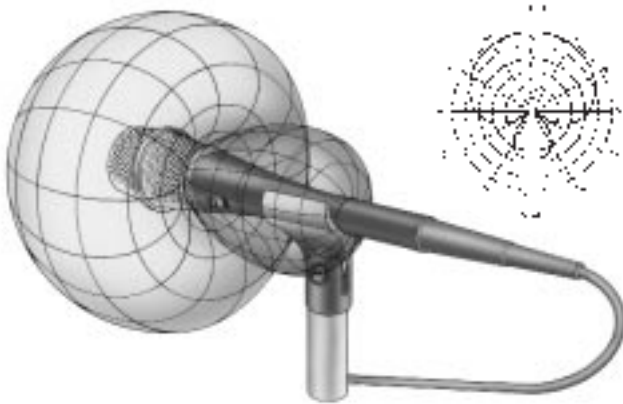

Supercardioid Microphone

CHAPTER FOUR

MICROPHONES:
CHARACTERISTICS, SELECTION

and resembles a “figure 8” pattern. Although the front coverage angle of a bidirectional microphone is only 90 degrees, it has equal rear coverage. The null angle is at 90 degrees, which is directly at the side of the microphone. While the bidirectional microphone is not used by itself in any typical house of worship sound application, it is occasionally used in combination with other types for stereo sound reproduction.

It should be noted that this discussion of directionality assumes that the polar pattern for a microphone is uniform, that is, the same shape at all frequencies. In practice, this is not always achieved. Most microphones maintain their “nominal” polar pattern over only a limited range of frequencies. This is the reason that published polar patterns include curves measured at several frequencies. High-quality, well-designed microphones are distinguished by the uniformity of their polar pattern over a wide frequency range and by the similarity of the pattern to the theoretical ideal.

Bidirectional Polar Pattern

the uniformity of their polar pattern over a wide frequency range and by the similarity of the pattern to the theoretical ideal.

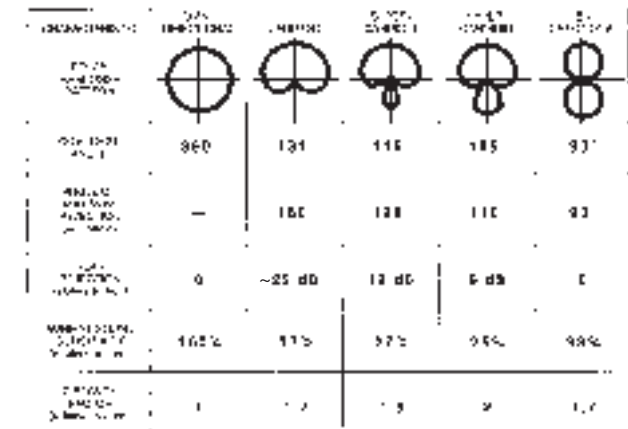

Characteristics

There are a few operational differences between omnidirectional and unidirectional microphones. A useful feature of most unidirectional types is *proximity effect*. This refers to the increased low-frequency response of a unidirectional microphone when it is placed closer than 1 or 2 feet to the sound source. It becomes most noticeable at very short distances: a substantial boost in the bass response at less than 2 inches. In particular, for closeup vocal use, proximity effect can add fullness and warmth to the sound and therefore may be desirable for many voices. Omnidirectional microphones do not

exhibit proximity effect. In addition, omnidirectional microphones are less sensitive to wind noise and to handling noise. Most quality unidirectional types have effective built-in windscreens and shock mounts to compensate.

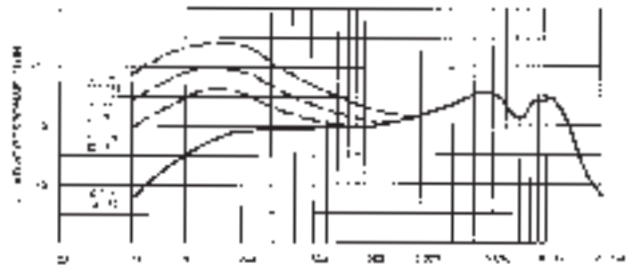

Proximity Effect Graph

Selecting an omnidirectional or unidirectional microphone again depends on the sound source and the destination of the audio signal. For recording (but not sound reinforcement) of choral groups, orchestras, or even the congregation, an omnidirectional microphone may be used to pick up sound from all directions rather than emphasizing individual voices or instruments. However, as part of a sound reinforcement or P.A. system, an omnidirectional microphone may be more prone to feedback because it cannot be aimed away from the loudspeakers. (See page 34 for more discussion of feedback.)

A unidirectional model can not only help to isolate one voice or instrument from other singers or instruments, but can also reject background noise. In addition, a properly placed unidirectional microphone can minimize feedback, allowing higher sound reinforcement levels. For these reasons, unidirectional microphones far outnumber omnidirectional microphones in day-to-day use, in almost all worship facility sound applications.

4) Electrical output: How does the microphone output match the sound system input?

The electrical output of a microphone is characterized by its sensitivity, its impedance, and by its *configuration*. The same characteristics are used to describe microphone inputs in sound systems. This determines the proper electrical match of a microphone to a given sound system.

The *sensitivity* of a microphone is defined as its electrical output level for a certain input sound level. The greater the sensitivity, the higher the electrical output will be for the same sound level. In general, condenser microphones have higher sensitivity than dynamic microphones of comparable quality. It should be noted

CHAPTER FOUR

MICROPHONES:
CHARACTERISTICS, SELECTION

that for weak or distant sound, a microphone of high sensitivity is desirable, while loud or closeup sound can be picked up well by lower-sensitivity microphones.

Impedance is, approximately, the output electrical resistance of the microphone: 150-600 ohms for low impedance (low Z), 10,000 ohms or more for high impedance (high Z). While the majority of microphones fall into one of these two divisions, there are some that have switchable impedance selection. In any case, the choice of impedance is determined by two factors: the length of cable needed (from the microphone to the microphone input) and the rated impedance of the microphone input.

The maximum length of cable that may be used with a high-impedance microphone should be limited to no more than 20 feet. For longer cable lengths, the high-frequency response of the microphone will be progressively diminished. Low-impedance microphones, on the other hand, may be used with cable lengths of 1000 feet or more with no loss of quality, and are therefore preferable for most applications.

The output configuration of a microphone can be either balanced or unbalanced. A *balanced output* carries the signal on two conductors (plus shield). The signals on each conductor are the same level but they are of opposite polarity (one signal is positive when the other is negative). Most microphone mixers have a balanced (or differential) input which is sensitive only to the difference between the two signals and ignores any part of the signal that is the same in each conductor. Because of the close proximity of the two conductors in a balanced cable, any noise or hum picked up by the cable will be the same level and the same polarity in each conductor. This *common-mode* noise will be rejected by the *balanced input*, while the original balanced microphone signal is unaffected. This greatly reduces the potential for noise in balanced microphones and cables.

An *unbalanced output* signal is carried on a single conductor (plus shield). An *unbalanced input* is sensitive to any signal on that conductor. Noise or hum that is picked up by the cable will be added to the original microphone signal and will be amplified along with it by the unbalanced input. For this reason, unbalanced microphones and cables can never be recommended for long cable runs, or in areas where electrical interference is a problem.

The two most common microphone output types and mixer input types are Balanced Low-Impedance and Unbalanced High-Impedance. Since all high-quality and even most medium-quality microphones have a *balanced, low-impedance output*, this is the recommended type for

How a Balanced Input Works

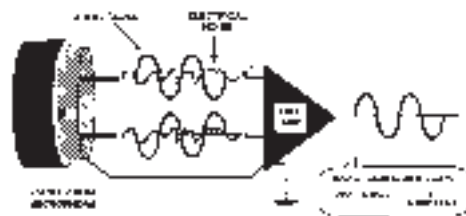

How an Unbalanced Input Works

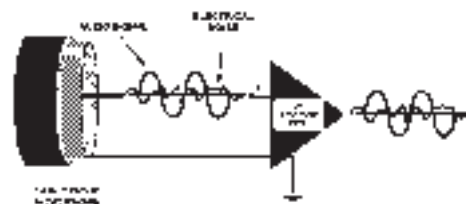

Balanced and Unbalanced Cables and Connectors

the majority of worship facility sound system applications, especially when long cable runs are used.

5) Physical design: How does the mechanical and operational design relate to the intended application?

Microphones for house of worship sound applications include several typical designs: handheld, user-worn, free-standing mounted, and boundary or surface mounted. Each is characterized by a particular size, shape, or mounting method that lends itself to a specific manner of use. In addition, some microphones may be equipped with special features, such as on-off switches, that may be desirable for certain situations.

Handheld types are widely used for speech and singing in many areas of worship facility sound. Since they are usually handled, passed from person to person, or used while moving about, they must have a very effective internal shock mount to prevent pickup of handling noise. In addition, they are often used very close to the mouth and should therefore be equipped with an effective "pop" filter or windscreen to minimize explosive breath sounds. Size, weight and feel are important considerations for a handheld microphone.

CHAPTER FOUR

MICROPHONES:
CHARACTERISTICS, SELECTION

User-worn microphones include clip-on types that may be attached directly to clothing, lavalier styles worn on a lanyard around the neck, or possibly head-worn types. These are used when a relatively unobtrusive microphone must be located close to the user's mouth and especially for applications in which the wearer moves about or needs hands-free operation. Size and appearance are critical in the selection of user-worn microphones.

Free-standing mounted microphones (mounted away from large surfaces) come in a variety of styles suited for different fixed settings. These range from full-size microphones on heavy-duty stands, to miniature types on unobtrusive goosenecks or booms, to overhead microphones of any size. Mounted microphones are generally selected for permanent installation, although many handheld types may be placed in mounts and removed as needed. Shock isolation is essential if the stand is likely to be moved or is mounted on a vibrating stage or hollow lectern. Windscreens are necessary for close-up vocals or if used outdoors. Again, appearance is often a primary factor in mounted microphones.

Boundary or *surface-mounted* microphones are also used in fixed positions, but the surface to which they are attached is essential to the operation of the microphone.

These microphones are most successfully mounted on existing surfaces (such as altars, floors, walls, or ceilings) to cover a certain area. They depend to a great extent on the acoustic properties of the mounting surface (size, composition, orientation) for their frequency response and directionality. However, they offer a very low profile and can minimize certain acoustic problems due to reflected sound. Appearance and physical environment play an important part in the selection of boundary microphones.

It should be noted that almost any combination of the other four microphone characteristics can be found in any of the physical designs mentioned here. That is, most of these designs are available in a choice of operating principle, frequency response, directional pattern, and electrical output.

Though not intrinsically related to the other four areas of microphone specification, the physical design is no less important in the selection process and, indeed, is often one of the first choices dictated by the application. In any case, the other microphone specifications should be just as carefully chosen to satisfy the basic acoustic and electrical requirements of the application. Ultimately, all five characteristics must be properly specified to yield the best results.



A Selection of Microphone Designs

MICROPHONES: USE

Once a microphone is selected for a given application, it must be used properly to get the best possible results. Again, there are two key areas: the interface of the microphone with the *sound source*, and the interface of the microphone with the *sound system*. The first area involves primarily acoustic considerations for optimum placement of one or more microphones. The second area involves electrical and mechanical considerations for optimum operation of microphones.

Microphone Placement

Microphone placement is a challenge that depends on the acoustic nature of the sound source and the acoustic characteristics of the microphone. Although this may appear to be a very subjective process, a description of some of the important acoustic considerations will lead to a few simple rules for successful microphone placement.

Recall that sounds can be categorized as desired or undesired and that the soundfield, or total sound in a space, is made up of both direct sound and ambient sound. The level of direct sound decreases with distance (the inverse-square law) while ambient sound stays at a constant level. The *critical distance* is the distance (from the sound source) at which the level of direct sound has fallen to the level of the ambient sound. Critical distance is determined by the loudness of the direct sound relative to the loudness of the ambient sound. A quiet talker in a noisy room has a short critical distance while a loud talker in a quiet room has a longer critical distance. In practice, microphones must be placed much closer than the critical distance to get an acceptable ratio of direct-to-ambient sound.

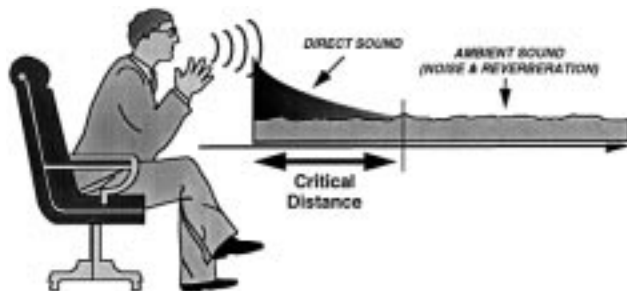

Critical Distance

This brings up the concept of “reach”, or distant pickup capability. The proportion of direct vs. ambient sound picked up by a microphone is a function not only of distance but of the directional pattern of the microphone as well. For a given ratio of direct-to-ambient sound, a

unidirectional microphone may be used at a greater distance from the direct sound source than an omnidirectional type. This is called the *distance factor*, and ranges from about 1.7 for a cardioid, to 2.0 (twice the omni distance) for a hypercardioid. See chart on page 15.

For instance, if an omnidirectional microphone picked up an acceptable direct-to-ambient sound ratio at 2 feet from the sound source, then a cardioid would have the same ratio at about 3.4 feet, although the gain would have to be increased to achieve the same output level. However, for a very weak source, or a very high ambient sound level, the acceptable omni location (again, *less* than the critical distance) could be as little as 3 inches away, for example. In this case, even a hypercardioid could only be used 6 inches away. Reach is thus a very subjective concept and is dominated by the actual direct vs. ambient sound level at the *microphone position* rather than by the directionality of the microphone: even an omni would have excellent reach, if no ambient sound were present. Note that directional microphones are *not* more sensitive to on-axis sound. They are just *less* sensitive to off-axis sound!

Feedback

In the normal operation of a sound system, some of the sound produced by the loudspeakers is picked up by the microphone and re-enters the system. As the gain of the system is increased, the level of the sound from the loudspeakers at the microphone also increases. Eventually, at some gain setting, this re-entrant sound will be amplified to the same level as the original sound picked up by the microphone. At this point the system will begin to “ring” or oscillate. Higher gain will result in the sustained “howl” or drone known as feedback.

There are many factors that affect the potential acoustic gain (maximum gain-before-feedback) of a sound system. By far, the most important ones are the relative distances between the sound source and the microphone, between the microphone and the loudspeaker, and between the loudspeaker and the listener. The number of “open” or active microphones also plays a strong role. These factors are discussed in Appendix Two: Potential Acoustic Gain.

Lesser factors are the directional characteristics of the microphones and loudspeakers, local acoustical reflections, room reverberation, and the overall frequency response of the sound system. Use of directional microphones and directional loudspeakers can reduce the amount of direct sound picked up by the microphone from the loudspeaker by aiming them away from each other. Of course this is limited by the

MICROPHONES: USE

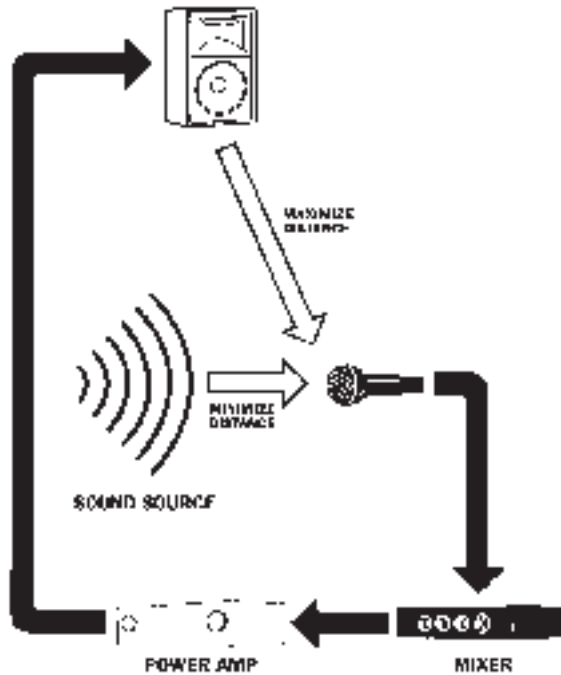

Acoustical and Electrical Feedback Path

directional or “pattern” control of the devices. In practice, loudspeakers have very little directivity at low frequencies (where the wavelength is large compared to the speaker size).

Acoustic reflections from objects near the microphone can aggravate feedback problems. For example: sound from a monitor speaker placed behind the microphone can reflect off the performer’s face into the front of the microphone, or a lectern surface can reflect the sound from an overhead cluster. Placing a hand on the front of or around the grille of a microphone can severely disrupt its polar pattern and frequency response.

Room reverberation increases the overall sound level throughout the room. Because it causes sound to persist even after the source stops, ringing and feedback tend to be more sustained. Since reverberation is not uniform with frequency it may also increase the likelihood of feedback at certain frequencies.

In fact, the overall frequency response of the sound system is affected by each component in the system as well as the room response. Feedback occurs first at the frequency that has the highest sensitivity in the system response curve. A peak in the response of a microphone

or loudspeaker or an unusual boost in an equalizer can trigger feedback as the system gain is increased. Flat response systems can generally operate with more gain-before-feedback. Judicious use of equalizers can improve the stability of a sound system if feedback is occurring just at a few specific frequencies. However, equalizers will not allow the system to exceed the inherent limits of the PAG calculation.

This leads to the first and most important rule of microphone placement: ***Place the microphone as close as practical to the desired sound source.***

It has several corollaries: place the microphone as far as possible from loudspeakers and other undesired sources; use directional microphones to minimize ambient sound pickup; aim directional microphones toward the desired sound and/or away from undesired sound; and keep the system gain to a minimum.

Ultimately, the position chosen should be consistent with the characteristics of both the sound source and the microphone: larger sources, such as a choir, may require greater distance, depending on the microphones’ directionality; extremely loud sources may require greater distance to avoid overload of some sensitive condenser microphones; and close vocal use requires adequate “pop” filtering. In any case, following the above rules will give the best pickup of the desired sound, the minimum pickup of undesired sound, and the least likelihood of feedback.

**NOT ENOUGH GAIN-BEFORE-FEEDBACK?
HERE IS WHAT YOU CAN DO:**

(In order of importance)

- Move microphones closer to sources
- Move loudspeakers farther from microphones
- Move loudspeakers closer to listeners
- Reduce the number of open microphones
- Use directional microphones and loudspeakers
- Eliminate acoustic reflections near microphones
- Reduce room reverberation by acoustic treatment
- Use equalizers to reduce system gain at feedback frequencies

There are no other solutions!

MICROPHONES: USE

Interference Effects

An important consideration in microphone use is *acoustic interference*. Interference effects may occur whenever delayed versions of the same sound are mixed together, acoustically or electrically. With microphones, this may happen in several ways: microphones of reverse polarity picking up the same sound, multiple microphones picking up the same sound from different distances, a single microphone picking up multiple reflections of the same sound, or any combination of these. The results are similar in each case, and include audible peaks and dips in frequency response, apparent changes in directionality, and increased feedback problems.

The first situation, *reverse polarity*, will result in severe loss of sound, especially low frequencies, when a microphone with reverse polarity is placed next to another of correct polarity and set to the same level. Signals from the microphones are then of equal strength but of opposite polarity. When these signals are combined in a mixer the cancellation is nearly total.

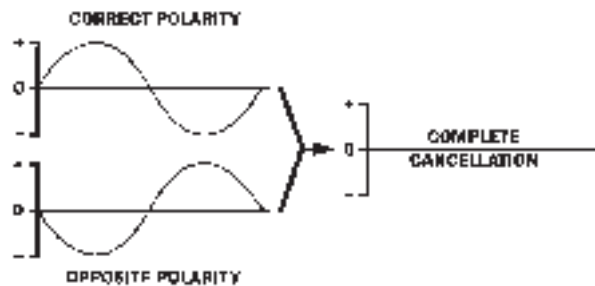
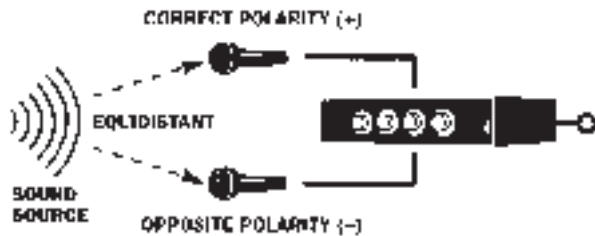

Polarity Reversal

Although there is an international standard for microphone polarity (pin 2+, pin 3-), a reversal may be found in an incorrectly wired microphone cable. It can be identified by checking each microphone and cable against a microphone and cable that are known to be correct. **In any installation, all microphones and microphone cables must have the same polarity.**

The second form of interference is the result of *multiple microphone pickup* and can occur whenever more than one microphone is used. If the microphones are at

unequal distances from the sound source, the sound picked up by the more distant microphone will be delayed relative to the near microphone. When these signals are combined in a mixer, peaks and notches occur at multiple frequencies which are related to the delay time, and hence, to the distances between the microphones. This effect is called “comb filtering” because the resulting frequency response curve resembles the teeth of a comb. As the delay time increases, comb filtering starts at lower frequencies. It is especially noticeable at middle and high frequencies, and creates a “hollow”, distant sound.

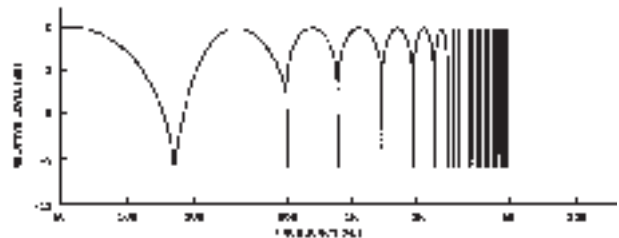
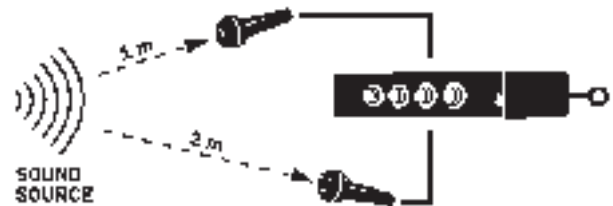

Multi-mic Comb Filtering

The solution to this problem is to use the *three-to-one rule*: for multiple microphones, the microphone-to-microphone distance should be at least three times the source-to-microphone distance.

For example, when using individual microphones on a vocal group, if a singer’s microphone is one foot away, then the next nearest microphone should be at least three feet away from the first. This insures that direct sound from the singer will not be strong enough to cause noticeable interference when picked up by the more distant microphones. As the source-to-microphone distance increases, the distance to adjacent microphones must also be increased.

An implication of the three-to-one rule is the following: **avoid picking up the same sound source with more than one microphone.** Microphones should be placed and aimed to minimize areas of overlapping coverage. This is important for a number of sound applications: for area pickup applications, such as choir lofts and stages, each section or area should be covered by only one microphone;

MICROPHONES: USE

for lectern applications, only one microphone should be used; when a lavalier microphone wearer speaks into a fixed microphone, one of the microphones should be turned down.

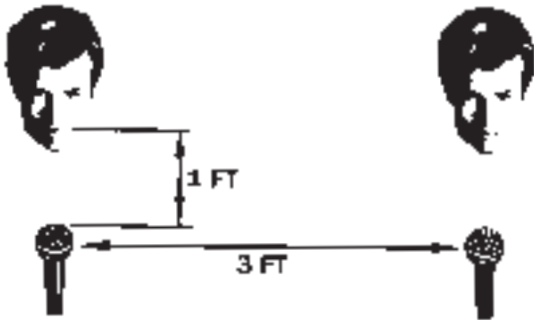

3 to 1 Rule

The third form of interference, *reflection pickup*, may occur whenever there are nearby sound-reflecting surfaces. This is often true in worship facility settings: hardwood or stone floors, brick or glass walls, wood or plaster ceilings, and solid lecterns and altars. Recall that reflected sound is always delayed relative to direct sound. When the delayed, reflected sound arrives with the direct sound at the microphone, acoustic comb filtering is again the result.

The first solution is to increase the direct sound level by placing the microphone as close as practical to the sound source, so that the direct sound is much stronger than the reflected sound. Interference effects only become noticeable when the reflected sound is comparable in level to the direct sound. However, close placement may not be possible in the case of area coverage or moving sound sources.

The second solution is to decrease the reflected sound level. The microphone may be moved away from the reflective surface, or re-oriented for minimum pickup of sound from that direction. The acoustically reflective surface may possibly be moved away, re-oriented, or treated with some sound-absorbent material. However, this is often not feasible, for economic or aesthetic reasons.

The third alternative is to minimize the delay. Since the delay is due to the difference in the paths of the direct and reflected sound, this can be accomplished by moving the microphone close to the reflective surface, so that the direct sound and the reflected sound have nearly the same path. This raises the frequency at which comb filtering starts. If the microphone can be brought very close to the surface (within one-quarter inch), any comb filtering will occur above the audible range.

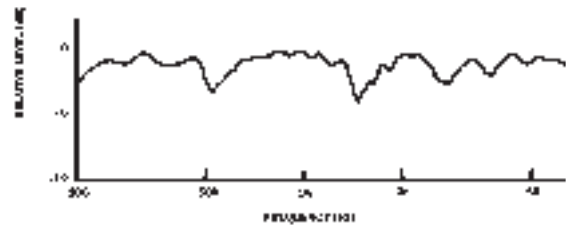
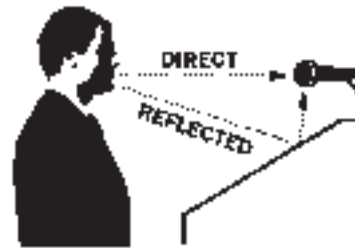
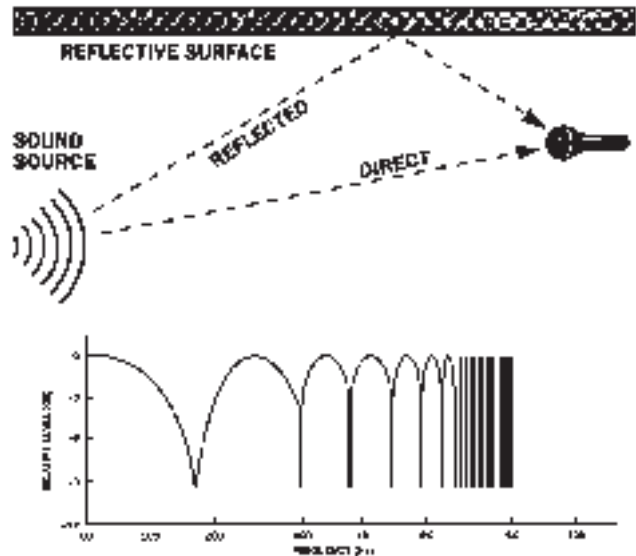

Reflection Pickup

Surface-mount or “boundary effect” microphones are designed to effectively reduce interference from the surface on which they are located. If they are located at the junction of two or more surfaces, such as the corner of a room, they reduce interference from each adjacent surface. In addition, a boundary microphone exhibits increased output due to its combining of the direct and reflected sound energy.

To minimize reflection pickup, **avoid using microphones near acoustically reflective surfaces.** If this is not possible, consider using a surface-mount microphone on the primary reflecting surface.

In addition to interference problems, the use of *multiple microphones* creates other potential difficulties. One of these is due to the fact that as the number of active

MICROPHONES: USE

microphones in a sound system increases, the overall system gain or volume also increases. (See Appendix Two: Potential Acoustic Gain.) This has the effect of increasing feedback problems. And, of course, each active microphone is adding more ambient noise pickup to the system.

This leads to a final general rule for microphone use: **Always use the minimum number of microphones.** If additional microphones are not needed, they may actually degrade the sound system. If the application can be satisfied with one microphone, use only one microphone!

Microphone Hookup

The second key area of microphone use is the interface of the microphone with the sound system. As mentioned at the beginning of this section, this involves primarily electrical considerations. We will develop a few simple rules for proper interface based on the electrical characteristics of the microphone output and the sound system input, and on the requirements for cables and connectors to achieve maximum reliability.

In the discussion of operating principle it was mentioned that all condenser microphones require power for their operation. This is provided by an internal battery in some models, or by phantom power in others. If a condenser is selected, care must be taken to assure that the appropriate power source (battery or phantom) is available. A battery-powered condenser is fine for applications such as portable recording but **phantom power should be used for any permanent microphone installation.**

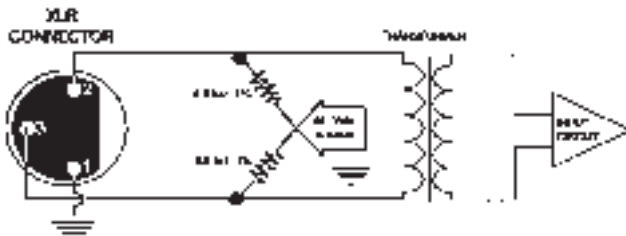

Phantom Power Schematic

Phantom power, sometimes called “simplex”, is provided through the microphone cable itself. It is a DC (direct current) voltage that may range from 9 to 48 volts, depending on the microphone requirement and the phantom power source rating. This voltage is applied equally to the two conductors of a balanced microphone cable, that is pin 2 and pin 3 of an XLR-type connector. The voltage source may be either in the mixer itself or in a separate phantom power supply connected in line with the microphone cable. Most recent mixers have phan-

tom power built in, and the actual voltage will be stated on the mixer or in the operating manual.

The voltage requirement for a phantom-powered condenser microphone will also generally be stated on the microphone or in the manufacturer's literature. Some types, particularly those that are externally charged, may require a full 48 volt supply. *Electret* types, which have a permanent charge, will typically operate over the entire range from 12 to 48 volts. Unless specifically stated otherwise by the manufacturer, these microphones will deliver their full performance at any voltage in this range, and further, they will *not* be damaged by a full 48 volt supply. Supplying *less* than the recommended voltage to either type may result in lower dynamic range, higher distortion, or increased noise, but this also will not damage the microphone.

Dynamic microphones, of course, do not require phantom power. However, many mixers have only a single switch that supplies phantom power to all microphone inputs, which may include some used by dynamic microphones. The presence of phantom power has no effect on a balanced, low-impedance dynamic microphone. It is not possible to damage or impair the performance of a balanced microphone correctly hooked up to any standard phantom supply.

If a balanced microphone is incorrectly wired or if an unbalanced, high-impedance microphone is used, there may be a loud “pop” or other noise produced when the microphone is plugged in or switched on. In addition, the sound of the microphone may be distorted or reduced in level. Even in these cases, the microphone will still *not* be damaged and will work normally when the wiring is corrected or the phantom power is turned off. If an unbalanced microphone must be used with a phantom-powered input, an isolating transformer should be used. By the same token, it is also not possible to damage any standard power source by improper microphone connection.

Good phantom power practices are:

- **check that phantom voltage is sufficient** for the selected condenser microphone(s);
- **turn system levels down** when connecting or disconnecting phantom-powered microphones, when turning phantom power on or off, or when turning certain phantom-powered microphones on or off;
- **check that microphones and cables are properly wired.**

Following these practices will make condenser microphone use almost as simple as that of dynamics.

MICROPHONES: USE

PHANTOM POWER VS. BIAS VOLTAGE

In a condenser microphone, one function of the circuitry is to convert the very high impedance of the condenser element to a lower impedance. For an electret condenser (the most common type) this is done by a single transistor. Some condenser designs, such as lavalier types or miniature hanging types, have their electronics separate from the microphone element. In these models, the impedance converting transistor is built in to the microphone element itself. The main part of the circuitry is contained in a separate module or pack usually connected to the element by a thin shielded cable.

The main electronics of such designs operate on phantom power supplied through the microphone cable or by means of a battery in the pack itself. However, the impedance-converting transistor in the microphone element also requires power in a form known as "bias" voltage. This is a DC voltage, typically between 1.5 and 5 volts. It is carried on a single conductor in the miniature connecting cable, unlike phantom power which is carried on two conductors in the main microphone cable. In addition, the audio signal in the miniature cable is unbalanced while the signal in the main cable is balanced.

This distinction between phantom power and bias voltage is important for two reasons. The first concerns the use of wireless transmitters. Body-pack transmitters which operate on 9 volt (or smaller) batteries cannot provide phantom power (12-48 volts DC). This prevents their use with phantom-powered condenser microphones. However, the body-pack transmitter can provide bias voltage (1.5-5 volts DC). This allows a condenser microphone element with an integrated impedance-converting transistor to be used directly with a body-pack transmitter. Miniature condenser lavalier types as well as other designs which have separate electronics can be operated with wireless systems in this way.

The second reason concerns the wired installation of condenser microphones with separate electronic assemblies such as miniature hanging microphones for choir, congregation, or other "area" applications. Since the audio signal in the cable between the microphone element and the electronics is unbalanced, it is more susceptible to pickup of electronic noise. This is particularly true for radio frequency noise because the cable itself can act as an antenna, especially for a nearby AM radio station. For this reason it is strongly recommended to keep the length of this part of the cable as short as possible, preferably less than 35 feet. It is a much better practice to extend the length of the balanced cable between the electronics assembly and the mixer input.

For the expected sound level, *microphone sensitivity* should be high enough to give a sufficient signal to the mixer input. In practice, most mixers are capable of handling a very wide range of microphone signal levels. Occasionally, for extremely high sound levels, an "attenuator" may be necessary to lower the output of the microphone. These are built into some microphones and mixers. Otherwise, accessory attenuators are available that may be inserted in line with the microphone cable.

It has already been mentioned that **balanced, low-impedance microphones are recommended for the majority of worship facility sound applications.** This will allow the use of long microphone cables, and result in the least pickup of electrical noise. In any case, the microphone impedance should be similar to the rated impedance of the microphone input of the mixer or other equipment. **It is not necessary or even desirable to match impedances precisely.** It is only necessary that the actual input impedance be greater than the microphone output impedance. In fact, the actual impedance of a typical microphone input is normally five to ten times higher than the actual output impedance of the microphone. The microphone input impedance of most mixers ranges from 1000 ohms to 3000 ohms, which is suitable for microphones of 150 ohms to 600 ohms.

When it is necessary to match a balanced, low-impedance microphone to an unbalanced, high-impedance input, or vice versa, *transformers* with the appropriate input and output connectors are readily available. Transformers provide an impedance matching function and can also change the configuration from balanced to unbalanced as needed. Ideally, transformers should be connected so that the bulk of the cable run is balanced, low-impedance, for maximum allowable length and minimum noise pickup. This would normally place the transformer at the connector of the unbalanced, high-impedance device.

Professional (and most semi-professional) equipment has balanced, low-impedance microphone inputs using 3-pin XLR-type connectors. Less sophisticated musical instruments, consumer electronic products, and many tape recorders typically have unbalanced, high-impedance microphone inputs using 1/4 inch phone jacks or 1/8 inch mini-phone jacks. A few mixers offer both types of connectors for each input channel. Simple adapters may be used to mate different types of connectors if no configuration change (high/low impedance or balanced/unbalanced signal) is necessary. **Use only high-quality connectors and adapters.**

MICROPHONES: USE



In-Line Transformers

Optimum microphone performance depends on the associated connectors and cables. In addition to quality connectors of the types described above, it is equally important to use high-quality cables. Beyond the basic specification of *balanced* (two conductors plus shield) or *unbalanced* (one conductor plus shield), there are several other factors that go into the construction of good cables.

The *conductors*: carry the actual audio signal (and phantom voltage for condensers), usually stranded wire. They should be of sufficient size (gauge) to carry the signal and provide adequate strength and flexibility; use stranded conductors for most applications, solid conductors *only* for stationary connections.

The *shield*: protects the conductors from electrical noise, may be braided or spiral wrapped wire, or metal foil. It should provide good electrical coverage and be flexible enough for the intended use: braid or spiral for movable use, foil *only* for fixed use such as in conduit.

The *outer jacket*: protects the shield and conductors from physical damage, may be rubber or plastic. It should be flexible, durable, and abrasion resistant. Depending on the location it may need to be chemical or fire resistant. Different color jackets are available and can be used to identify certain microphone channels or cables.

A large percentage of microphone problems are actually due to defective or improper microphone cables. Microphone cables should be handled and maintained carefully for long life: position them away from AC lines and other sources of electrical interference to prevent hum; allow them to lie flat when in use to avoid snagging; use additional cable(s) if necessary to avoid stretching; do not tie knots in cables; coil loosely and store them when not in use; periodically check cables visually and with a cable tester.

Individual, pre-assembled microphone cables are readily found in a wide variety of styles and quality. In addition, multiple cable assemblies, called “snakes”, are available for carrying many microphone signals from one location to another, such as from the sanctuary to the sound booth. **The use of only high-quality cables and their proper maintenance are absolute necessities in any successful worship facility sound application.**

Finally, the use of microphones for particular applications may be facilitated by microphone accessories. These are mechanical and electrical hardware items that are often used in mounting and connecting microphones.

Mechanical accessories include various kinds of acoustic devices such as windscreens and directionality modifiers. Windscreens, usually made of special foam or cloth, should be used whenever microphones are used outdoors or subjected to any air currents or rapid motion. “Pop” filters are employed when the microphone is used close to the mouth, such as on lecterns or for handheld vocals. These minimize noise caused by explosive consonants such as “p”, “b”, “t”, or “d”. Although such filters are usually supplied with microphones designed for these applications, additional protection may be needed in some cases. Use only high-quality screens and filters to avoid degrading the sound of the microphone.

There are directional or “polar” modifiers available for certain microphones that can change the pickup pattern from cardioid to supercardioid, for example, or from omnidirectional to semi-directional in the case of some boundary microphones. Consult the manufacturer for proper use of these accessories.

MICROPHONES: USE

Mounting accessories are of great importance in many worship facility sound applications. Stands, booms, and goosenecks should be sturdy enough to support the microphone in the intended location and to accommodate the desired range of motion. Overhead hardware, to allow microphones to be suspended above a choir for example, must often include a provision for preventing motion of the microphone due to air currents or temperature effects. Stand adapters or “clips” may be designed for either permanent attachment or quick-release. “Shock mounts” are used to isolate the microphone from vibrations transmitted through the stand or the mounting surface, such as a lectern.

Electrical accessories such as transformers and phantom power supplies have already been described. In addition, there are a variety of signal processors which may be used directly in line with a microphone. These can range from simple low- or high-frequency filters to complete preamp/equalizer/limiter units, though most of these functions are normally provided by the mixer and subsequent elements of the audio chain.

Creative use of these accessories can allow microphones to be placed almost anywhere, with good acoustic results and with acceptable aesthetic appearance.



Microphone Accessories

WIRELESS MICROPHONE SYSTEMS

A wireless microphone is actually a system consisting of a microphone, a radio transmitter and a radio receiver. The function of the microphone is unchanged and the function of the transmitter and receiver combination is merely to replace the microphone cable with a radio link. Although this objective is simple, its accomplishment is not. However, with some knowledge of the components and characteristics of wireless microphone systems, and a clear idea of the intended application, the selection and use of wireless microphones can be made relatively straightforward.

1) The Microphone: How does sound enter the wireless system?

The selection process for the microphone part of a wireless system is exactly the same as for wired microphones: the microphone must be matched to the desired sound source and to the sound system. In this case, the sound system consists not only of the devices that make up the rest of the audio chain but the input to the radio transmitter as well. Acoustically, wireless and wired microphones behave identically: proper microphone choice and placement is still necessary to get the best sound and to avoid problems such as feedback.

Available microphone choices for wireless include dynamic or condenser types, with flat or shaped frequency response, omni- or unidirectional polar patterns, and a variety of physical designs: lavalier, handheld, headworn, etc. Almost any type of microphone may be used as part of a wireless system, the notable exception being phantom-power-only condensers. The choice depends on the specific application.

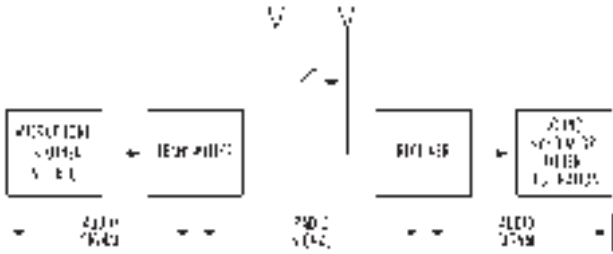

Radio System Diagram



Wireless System Components: Diversity Receiver, Body-Pack Transmitter, Handheld Transmitters, Headset and Lavalier Microphones

WIRELESS MICROPHONE SYSTEMS

2) The Transmitter: How does the microphone signal become a radio signal?

The transmitter uses the audio signal from the microphone to vary the frequency of a radio signal which is broadcast to the receiver. The principle is called “frequency modulation” or FM and is identical to that used by commercial FM radio stations. Electrically, the transmitter input must be compatible with the microphone output both in level and impedance. The transmitter input may also supply power for some condenser microphone elements. The transmitter itself is always battery-powered.

Physically, the transmitter takes one of two forms. The first is a small box, called a “body-pack” or “belt-pack”, that can be clipped to a belt or otherwise attached to the user. The microphone connects to the body-pack by means of a small cable. Some models have a detachable cable that allows the transmitter to be used with a variety of inputs. This form is most often used with lavalier microphones but can also be connected to electric musical instruments, head-worn microphones, and even handheld types with appropriate cables. All transmitters have a power on-off switch and many have a mute switch to silence the microphone without turning off the radio signal itself.

The second form is a transmitter that is built into the cylindrical body of the microphone itself. This is used almost exclusively for handheld vocal microphones and results in a package only slightly larger than a conventional wired microphone.

3) The Receiver: How is the radio signal turned back into an audio signal?

The receiver picks up the radio signal broadcast by the transmitter and extracts or “demodulates” the audio signal from it. Again the principle is the same as that of an ordinary FM radio. The output of the receiver is electrically identical to a microphone output and can be connected to any typical microphone input in a sound system. Some receivers have additional amplified outputs for headphones or auxiliary connections to sound systems. Although most receivers operate on ordinary AC power, battery-powered types are available for portable use.

Wireless receivers are also designed in two different configurations. The first is called *non-diversity* and consists of a single antenna and a single radio circuit. An ordinary FM radio is an example of a simple, non-diversity receiver.

Non-diversity receivers work well in many applications but are subject to a phenomenon known as multipath dropout: a temporary interruption of the radio signal. The audible effect may range from a slight “swishing” noise to a complete loss of sound.

Such dropouts may be experienced even at relatively short distances by a mechanism called multipath interference. Part of the signal from the transmitter (which radiates in all directions) travels directly to the receiver, but some of the signal is reflected to the receiver by metal objects or other structures. When the “paths” of the direct signal and of the reflected signal(s) are sufficiently different, they will interfere with each other when they combine at the receiver antenna. If the interference is great enough, partial or complete cancellation of the signal occurs, resulting in a dropout. It is similar to an extremely severe “ghost” in television reception, and the cure is the same: move the receiver antenna relative to the transmitter. This is not usually practical since it is the receiver antenna that is in a fixed location, while the wireless microphone location is constantly changing.

This introduces the concept behind the second wireless receiver configuration, called a *diversity system*. A diversity receiver utilizes two separate antennas and (usually) two separate radio circuits. When the two antennas are separated by even a short distance, the chance of a simultaneous interruption at both antenna positions is extremely low. The key to the system is additional “intelligent” diversity circuitry which continuously monitors the received signals and takes action according to the type of diversity employed.

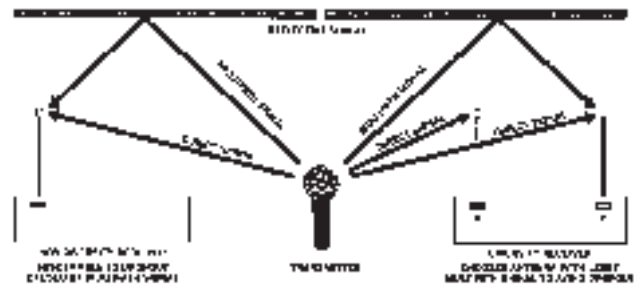

Receiver Illustration: Non-Diversity vs. Diversity

A simple, effective diversity technique is *antenna switching*. It employs two antennas with one radio section. The diversity circuitry switches antennas when it senses a problem at the audio output. This type of system cannot anticipate the result of switching and may thus switch unnecessarily at times.

A more effective diversity technique, known as *phase diversity*, again uses two antennas but only one radio circuit. The diversity circuitry adjusts the relative polarity of the antennas before combining them for optimum reception. This approach is less expensive, due to the

WIRELESS MICROPHONE SYSTEMS

single radio section, and works well when both antennas are getting a usable signal, but may not give the best results in the case of severe multipath interference, because it cannot anticipate the result of the switch.

Many diversity receivers are of the *receiver switching* type. These utilize two antennas and two radio sections. The diversity circuitry selects the better of the two received signals (but only one) by means of an electronic switch. If the switching is done quickly and quietly enough, the result is nearly dropout-free performance, with minimal audible side effects. Switching occurs only when it will improve the signal.

The fourth diversity design is known as the *receiver combining* type. This method takes advantage of the fact that *both* of the received signals are usable much of the time: in this case, using the signals from both antennas yields better reception than using only one signal (as in the switching type). The combining diversity circuitry adds the signals in proportion to their relative strength. When both are strong, the contribution from each signal is equal. If one signal becomes weaker, its contribution is similarly reduced. Finally, if a complete dropout occurs for one signal, the receiver uses only the good signal. Since the combining technique acts as a continuous balance control rather than as a switch, it further reduces any audible effects of diversity action. Again, it acts only when the signal can be improved.

Historically, diversity receivers have always been used for critical applications even though their cost was somewhat higher. Today, the cost of wireless systems in general and diversity systems in particular has decreased to the point that diversity receivers are used in the majority of higher-performance applications.

Since radio signals become weaker over greater distances, a dropout can also occur when the transmitter is very far from the receiver antenna. Or even at shorter distances when the radio signal from the transmitter is blocked by obstacles such as walls, equipment, or bodies.

An additional refinement in nearly all recent wireless systems is some form of noise reduction, or “companding”, in order to decrease the inherent noise and increase the limited dynamic range of radio transmission. The word **companding** refers to the two steps of the process: the signal is encoded (**compressed**) in the

transmitter before it is broadcast and then decoded (**expanded**) in the receiver in a complementary fashion. Although the principle of companding is similar in all wireless systems, significant differences between models make it undesirable to mix transmitters of one brand with receivers of another brand.

Other aspects of wireless microphone systems that must be considered in selection and use are operating frequencies, antennas, and radio interference. All three are especially important when planning the use of multiple wireless systems in the same location.

Every wireless microphone system transmits and receives on a particular radio frequency, called the *operating frequency*. These frequencies may be grouped into four bands: low-band VHF (49-72 MHz), high-band VHF (169-216 MHz), low-band UHF (450-806 MHz) and high-band UHF (806-952 MHz). VHF stands for “Very High Frequency”, UHF stands for “Ultra High Frequency”, and MHz stands for “MegaHertz” or millions of cycles-per-second. Use of these bands is regulated by the FCC (Federal Communication Commission) and certain frequencies within each band have been designated for use by wireless microphones as well as by other devices. It should be noted that while manufacturers must be licensed by the FCC to sell wireless equipment, it is the responsibility of the purchaser to observe FCC regulations regarding their actual use.

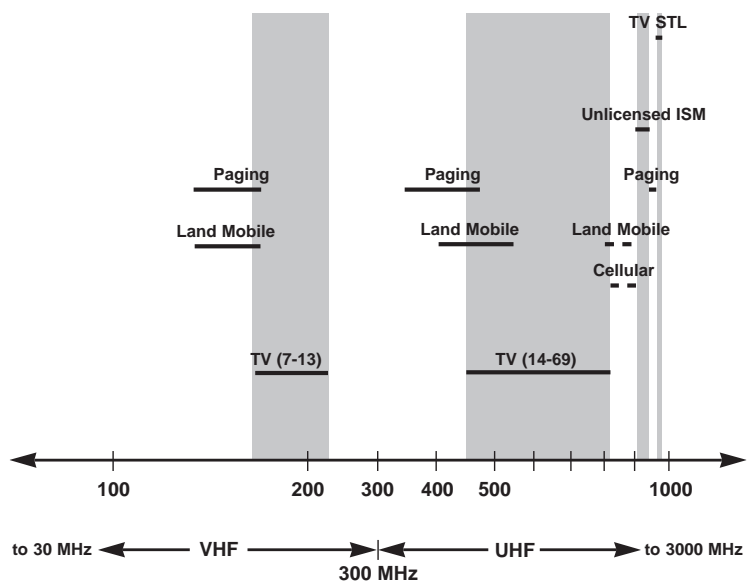

Frequency Band Illustration

WIRELESS MICROPHONE SYSTEMS

Low-band VHF, particularly 49 MHz, is shared not only by wireless microphones but by cordless telephones, walkie-talkies, and radio controlled toys. For this reason, it is almost never recommended for serious applications, even though systems in this range are very inexpensive.

The high-band VHF range is the most widely used for professional applications, and quality systems are available at a variety of prices. Although this range includes television channels 7-13, there are ample frequencies for use in any part of the country. The practical limitation for VHF is 10-12 simultaneous systems.

The two UHF bands, while free of many interfering signals found in the VHF bands, have traditionally been used only by very costly systems, due to more complex design and circuitry. However, as the price of UHF systems declines and the VHF band becomes more crowded, the UHF band may become increasingly attractive. UHF should be strongly considered when there is severe interference in the VHF band or whenever more than 10 systems need to operate simultaneously. VHF and UHF systems can generally be used together without interference. In addition, UHF antennas are only about 1/4 the size of VHF. Finally, tuneable UHF systems are more readily available.

Selection of operating frequency for a single wireless system simply involves choosing a locally unused frequency. Although there are tunable or "frequency agile" systems available, most equipment operates at a fixed frequency controlled by a quartz crystal which is installed and adjusted by the manufacturer. Most manufacturers can recommend a frequency that will generally work in a given geographic area. The difficulty arises when multiple systems must work together in the same location, or when travelling from one city to another.

Due to the nature of radio reception, **it is not possible for a single receiver to clearly pick up multiple transmitters on the same frequency.** Therefore, each transmitter must be on a separate frequency and have a corresponding receiver on that frequency. An additional complication is that simultaneously operating systems, even though they may be on different frequencies, may still interfere with each other if those frequencies are not carefully chosen. The rules for frequency selection are complex enough that computer programs are used to calculate compatible systems. Again, the wireless equipment manufacturer should be consulted for any multiple system installation.

Antenna selection and placement are very important aspects of wireless system operation. There are a few general rules about *antennas* to keep in mind.

First, maintain line-of-sight between the transmitter and receiver antennas if possible. Avoid metal or other dense materials between the two.

Second, keep the distance from transmitter to receiver as short as practical. It is much better to have the receiver near the transmitter and run the received audio signal through a long cable than to transmit over long distances or to use long antenna cables. The maximum legal signal strength of VHF systems is only fifty one-thousandths of a watt (50 mw)! However, it is recommended to maintain a minimum distance of 8 to 10 feet between a transmitter and its receiver if possible.

Third, use the proper receiver antenna: a "1/4-wave" antenna (about 17 inches long for high-band VHF) can be used if it is mounted directly to the receiver. If the antenna is to be located at a distance from the receiver, which will be necessary if the receiver is mounted inside a metal enclosure or at a great distance from the transmitter, a "1/2-wave" or other high "gain" (sensitivity) antenna should be used.

Fourth, mount antennas vertically and away from large metal objects. This applies to receiver and to transmitter antennas: do not coil or fold up trailing wire antennas (or microphone cable antennas) on body-pack transmitters. For diversity receivers, it is recommended to angle the antennas apart by 45 degrees from vertical.

Fifth, use the proper antenna cable for remotely locating receiver antennas: the correct impedance (usually 50 ohms) and the minimum length necessary (use low-loss cable for longer cable runs).

Sixth, mount multiple antennas properly: at least 1/4 wavelength apart (about 17 inches for high-band VHF systems). Use an amplified antenna distribution system (sometimes called an "active" antenna splitter) to minimize the number of antennas and to reduce interference problems with multiple receivers. This allows one antenna (or one pair, for a diversity system) to be used with multiple receivers.

WIRELESS MICROPHONE SYSTEMS

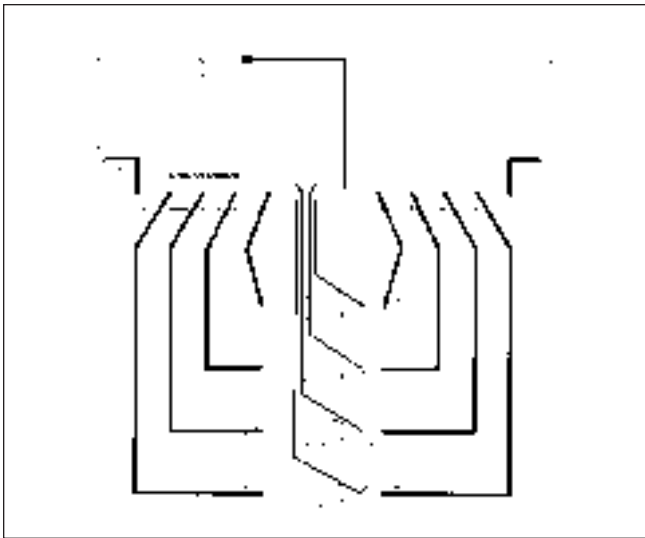

Antenna Distribution

The last aspect of the use of wireless microphone systems, and perhaps the least predictable is *radio interference*. We've discussed potential interference from other wireless systems operating on the same or nearby frequencies, but what about other possible sources of interference? High-band VHF systems are generally not subject to interference from radio stations, amateur radio, pagers or cellular telephones. Television stations 7-13 are a possibility but are very predictable. It is best to avoid frequencies within the bands of locally active TV channels. So-called "travelling" frequencies (169-172 MHz) are available that are just below the VHF television band, at the top of the two-way radio band. However, these are not recommended for most installations because of possible interference from two-way radio and paging services.

Local sources of interference may include the following: any type of digital device such as computers, digital signal processors, DAT or CD players; electronic musical instruments such as organs or synthesizers; neon or fluorescent light fixtures; large motors and generators; etc. Any electrical device that uses high voltage or high current, or any device that is marked with an FCC type rating is a potential source of radio frequency interference.

The selection of a wireless microphone system includes several steps, some of which are similar to wired microphone selection. It should be remembered that while wireless microphones cannot ultimately be as consistent and reliable as wired microphones, the performance of present systems can be very good, allowing excellent results to be obtained. **Following these steps will help select the best wireless system(s) for your application.**

First, define the application. In a worship facility system this may be a wireless lavalier microphone for the minister, a wireless handheld microphone for a singer, or even a wireless pickup for a musical instrument. Other applications could be meeting rooms or fellowship halls and various indoor or outdoor events.

Second, choose the microphone type. The application will usually determine which microphone type is required: a lavalier or clip-on type attached to clothing, or a headworn type, both for hands-free use; a handheld type for a vocalist or when the microphone must be passed around to different users; a connecting cable when an electrical musical instrument or other non-microphone source is used. Most handheld and headworn types are unidirectional, while lavaliers are usually omnidirectional. Unidirectional lavaliers are available for use when feedback or high ambient noise is a problem.

Third, choose the transmitter type. Again, the application will specify the choice. All but the handheld type will use some kind of body-pack transmitter. Some body-pack transmitters, especially those with a multi-use input connector, use a separate antenna wire while others use the permanently attached microphone cable as the antenna. A mute or audio on-off switch is desirable to avoid turning off the transmitter power when the microphone is not needed. Handheld types may have external or internal antennas. Transmitter batteries may be one of several types and their relative availability should be considered. Also, power consumption of transmitters varies, so be aware of expected battery life.

Fourth, choose the receiver type. The basic choice here is diversity vs. non-diversity. For reasons mentioned in the receiver section above, diversity receivers are recommended for all but the most budget-conscious applications. Non-diversity types will work well in many situations, but the extra insurance (and usually extra features) of the diversity receiver are worth the somewhat higher cost. Other features of the receiver such as headphone outputs, balanced outputs, different indicators, and potential for battery power may be desirable.

Fifth, determine the number of systems to be used. This should take into account future additions to the system: choosing a system that can only accommodate a few frequencies may someday be a limitation. It should also take into account existing wireless systems with which the new equipment must work.

Sixth, consult the manufacturer or a knowledgeable professional about frequency selection to integrate the planned number of systems. This must be done for any multiple system installation and should be done for even single systems to avoid potential interference problems.

WIRELESS MICROPHONE SYSTEMS

Once the wireless system(s) choice is made, and the equipment is correctly installed, proper use is necessary for satisfactory performance.

Good practice with any wireless system is to check out the system ahead of performance time, with all other systems and devices on. This will reveal potential problems that were not apparent in a wireless-system-only test.

Many receivers are equipped with an adjustable “squelch” control: this sets the basic sensitivity of the receiver to avoid picking up interfering signals, or background radio noise, when the transmitter is turned off or if a dropout occurs. It should be adjusted according to the manufacturer’s instructions.

Ideally, **transmitters should be turned on first, then receivers.** Once the system is on, use the “mute” or “mic” switch to turn off the audio if necessary. **Do not turn off the transmitter until after the event is over and/or the receiver is turned off.** This will avoid an “open” receiver, which can pick up other radio signals that may be present. Some wireless systems are equipped with special squelch circuits that do allow transmitters to be turned off without any noise or interference problems.

Finally, **always use fresh batteries of the correct type in the transmitter!** Most manufacturers recommend only

alkaline or lithium type batteries for adequate operation. Avoid rechargeable batteries: their actual voltage is usually less than stated, and they may not operate satisfactorily in a wireless transmitter. In addition, the actual operating time of a rechargeable battery is usually much less than an alkaline type.

Other wireless systems:

Two other wireless systems that may be found in worship applications are assistive listening systems and in-ear monitor systems.

Assistive Listening Systems are generally used to provide improved sound to individuals with hearing impairments. They may also be used to provide simultaneous translation of the service into other languages. They consist of a single transmitter and as many receivers as are required by members of the congregation. The transmitter is about the same size as a typical wireless microphone receiver with an attached antenna and is AC-powered. It is usually located in the sanctuary where it can broadcast throughout the room. The receivers are small, battery operated packs with an attached earpiece or, in some models, a coil that can work with the user’s hearing aid. These systems are FM radio types and operated in the 72 Mhz band which is reserved specifically for them. No license is required. The sound quality of Assistive Listening Systems is

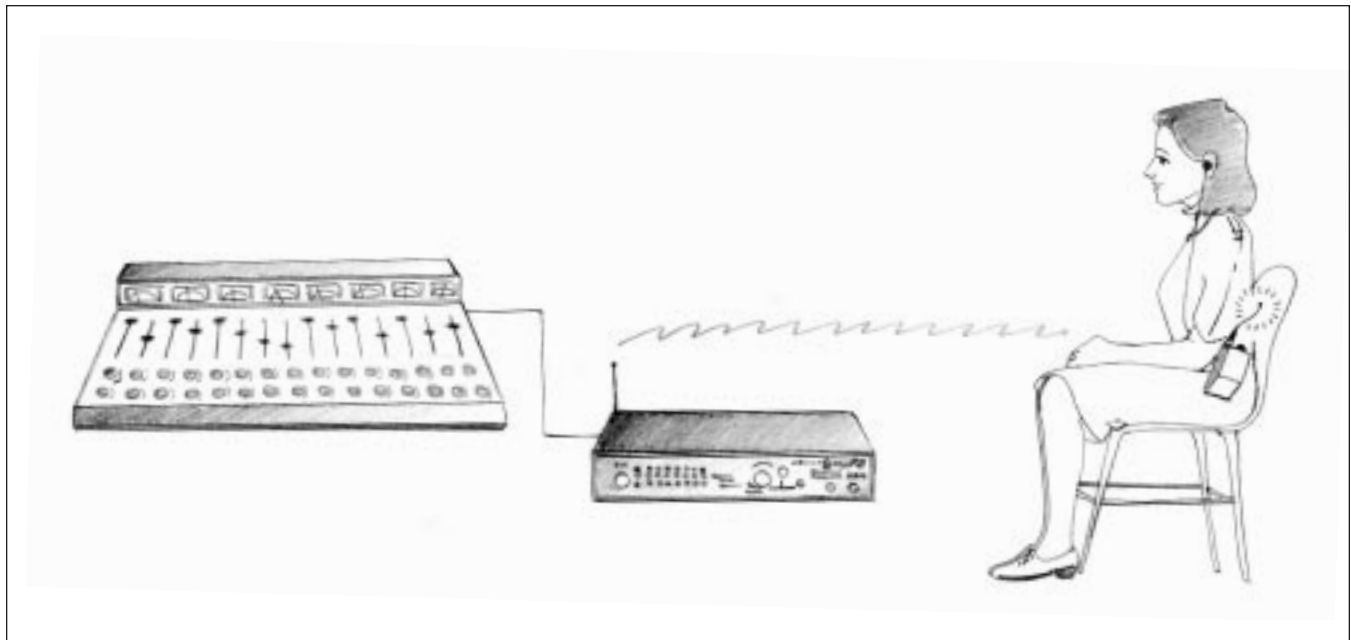

Example of an Assistive Listening System

WIRELESS MICROPHONE SYSTEMS

usually optimized for speech intelligibility and is typically monophonic. The source is usually a feed of the overall mix from the main sound system.

An alternative technology uses infrared transmitters and receivers. Again, a single transmitter is used with multiple receivers. The transmitter is a panel covered with multiple IR (infrared) emitters approximately one foot square and is also AC-powered. It is usually placed at an elevated location at the front of the sanctuary where listeners facing forward can see it. The receivers are sometimes a small clip-on pack with an IR sensor at the top or occasionally a headset with an attached IR sensor. Since these are not radio systems, there is no concern for frequency, licensing, or radio interference. The only operating concern is to avoid strong, direct sunlight on the receiver IR sensors.

Assistive Listening Systems are a reliable and relatively inexpensive technology, widely used in worship facilities, theaters, and schools. In fact, the Americans with Disabilities Act (ADA) requires their use in many public facilities. Receivers are usually made available to people at the worship facility for each use, but they are affordable enough that many individuals purchase their own receivers. Since the transmitters are fairly standardized, they can often be used at many different locations.

Another wireless technology that has applications in some worship facilities is the in-ear monitor system. These systems are used to provide monitoring or foldback directly to the ears of a performer. The system parts are essentially the

same as an Assistive Listening System: an AC-powered FM transmitter, a battery-powered body-pack receiver and earpieces. However, in-ear monitor systems are engineered to provide full-range, high-fidelity, stereo sound to listeners with normal hearing. Most of them operate in the UHF band which allows multiple system use and freedom from most radio interference. In addition, the ear-pieces are designed to seal out ambient sound to provide greater control of the foldback mix and a fair degree of hearing protection.

By replacing traditional monitor loudspeaker systems, in-ear monitors also eliminate many of the problems associated with these systems. These problems include monitor feedback, hearing damage from loud stage sound, and monitor “splash” or interference with the main sound system. In addition to these acoustic benefits, the bulk and expense of monitor speaker boxes, power amplifiers, and cables are also removed.

The source(s) for in-ear monitor systems is usually a combination of auxiliary mix outputs and/or direct channel outputs depending on the requirements of the listener. It is possible to customize a different mix for individual performers if each has his or her own transmitter/receiver. These systems are easily integrated with conventional mixers or dedicated monitor consoles.

Historically, in-ear monitor systems have been very expensive and were used only by major touring companies. More recently, these systems have become comparably priced to conventional monitor systems and their use is becoming more widespread.



Example of a Personal Stereo Monitor System, including Transmitter, Earphones, and Body-pack Receiver

AUTOMATIC MICROPHONE SYSTEMS AND SIGNAL PROCESSORS

The reasons for using an automatic microphone system relate to the behavior of multiple microphone systems. Each time the number of open or active microphones increases, the system gain or volume also increases. The effect of this is greater potential for feedback as more microphones are added, just as if the master volume control were being turned up. In addition, unwanted background noise increases with the number of open microphones. Here, the effect is a loss of intelligibility as the background noise level rises closer to the level of the desired sound. (See Appendix Two: Potential Acoustic Gain)



*Examples of automatic microphone mixers
(shown front and back)*

The solution is to activate microphones only when they are addressed and to keep them attenuated or turned down when not being addressed. In addition, when more than one microphone is addressed at a time, the system volume must be reduced appropriately to prevent feedback and insure minimum noise pickup.

An automatic microphone system is comprised of a special mixer and an associated group of microphones. The function of an automatic microphone system is twofold: to automatically activate microphones as needed and to automatically adjust the system volume in a corresponding manner. In some systems, ordinary microphones are used and all of the control is provided by the mixer. In others, special microphones are integrated with the mixer to provide enhanced control.

There are several techniques used to accomplish channel activation or “gating” in an automatic microphone system. In most systems, a microphone is gated on when the sound that it picks up is louder than some “threshold” or

reference level. When the sound level falls below the threshold, the microphone is gated off. This threshold may be fixed, adjustable, or even automatically adjustable. In any case, the threshold should be set so that the microphone is not activated by background noise but will be activated by normal sound levels.

Traditional threshold systems distinguish between background noise and the desired sound only by level. However, if background noise becomes sufficiently loud, it may activate microphones unless the threshold is adjusted to a higher level. Subsequently, if the background noise decreases, normal sounds may fail to gate the microphones on unless the threshold is lowered as well. Threshold adjustment is critical to automatic microphone systems of this type.

Some recent automatic mixers incorporate noise adaptive threshold circuitry. These have the ability to distinguish steady signals such as background noise from rapidly changing signals like speech. They can automatically and continuously adjust individual channel thresholds as ambient noise conditions change. In addition, some designs can recognize that the same signal is being picked up by more than one microphone. In that case, only the channel with the strongest signal is activated. This prevents both microphones from being activated when a talker is in between two microphones for example.

Certain other automatic systems, with integrated microphones, can actually sense the location of the sound source relative to the ambient noise and activate microphones only when the sound comes from the desired direction. These “directional gating” systems do not require any threshold adjustments.

There is another circuit within every automatic mixer that continuously senses the number of open microphones (NOM) and adjusts the gain of the mixer accordingly. With a properly functioning automatic system, if each individual microphone is adjusted to a level below the feedback point, then any combination of microphones will also be below the feedback point.

Many automatic microphone mixers have additional control circuitry, often in the form of logic connections. These are electrical terminals that can be used for a variety of functions, including: microphone status indicators, mute switches, loudspeaker attenuation, and the selection of “priority” channels. Some automatic mixers have an adjustable “off attenuation” control: instead of gating the microphone completely off, it can be “attenuated” or turned down by some finite amount, to make the gating effect less noticeable in certain applications. Another control included on some units is

AUTOMATIC MICROPHONE SYSTEMS AND SIGNAL PROCESSORS

an adjustable “hold time”: when the desired sound stops, the channel is held on for a short time to avoid gating the microphone off between words or short pauses. In addition, a function which locks on the last microphone activated insures that at least one microphone is on, even if no one is speaking. Finally, most automatic mixing systems are able to be expanded by adding individual channels and/or by linking multiple mixers together to control large numbers of microphones simultaneously.

An automatic microphone system should be considered whenever multiple microphones (four or more) are being used, particularly if the sound system is intended to run hands-free, that is, without a live operator. This is often the case not only in the worship facility itself but in fellowship halls, conference rooms, and auditorium systems. Microphones should be selected and placed according to the normal guidelines (integrated systems require a microphone choice from the selection available for those systems). It is recommended that the manufacturer or a qualified installed sound professional be consulted on the details of a particular automatic microphone system.

Signal Processors: Equalizers and Feedback Control

EQUALIZERS

Signal processors fall into three main categories based on which property of the audio signal they affect: *equalizers* affect frequency response, *dynamics controllers* affect amplitude, and *delays* affect time properties such as phase. Each of these can be useful in the operation of microphones but equalizers are of particular interest because of their potential use in feedback control.

Feedback is a very frequency-dependent phenomenon. Because it occurs first at peaks in the overall sound system frequency response, equalization of the response may significantly affect the onset of feedback. System response peaks may be due to many factors including system components, transducer location, or room acoustics. In principle, the system response must be reduced at those frequencies which trigger feedback. The goal is to allow the system to operate at higher gain without ringing or feedback.

Equalizers are frequency-dependent filters that fall into several categories based on the characteristics of the filters and their adjustment. *Hi-cut* and *lo-cut* (or, alternately, lo-pass and hi-pass) filters progressively attenuate or reduce all frequencies above (or below) a certain cutoff frequency. That is, the attenuation increases with frequency further above (or below) the cutoff frequency.

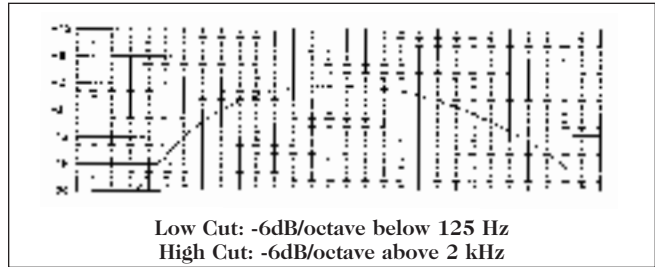

Low Cut and High Cut Filters

The cutoff frequency may be adjustable: down to 5000Hz for hi-cut and up to 500Hz for lo-cut. The “slope” or rate of attenuation may also be adjustable from a minimum of 6dB/octave to as steep as 24dB/octave. Hi-cut and lo-cut filters are used to reduce the *bandwidth* or frequency range of the signal to remove unwanted high frequency or low frequency sounds such as hiss or rumble.

Shelving equalizers allow low frequencies (or high frequencies) to be cut or to be boosted. The cut or boost is not progressive: it is the same at all frequencies below (or above) the filter frequency. The response curve looks somewhat like a shelf above or below the filter frequency. The amount of cut or boost is adjustable typically up to ± 15 dB. The filter frequency is usually fixed: about 250Hz and below for low frequencies, about 8000Hz and above for high frequencies. Shelving equalizers are used for general response shaping at low and high frequencies. They are the type of filter used as “bass” or “treble” tone controls.

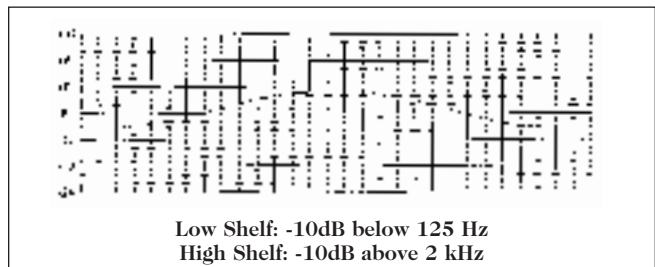

Shelving Equalizers

Bandpass equalizers allow frequencies within a certain band or range to be cut or boosted. They are classified according to their bandwidth and/or according to the number of filters employed. Bandwidth is usually given as a fraction of an octave (an octave represents a doubling of frequency such as 400Hz-800Hz or 4000Hz-8000Hz). For example, a midrange tone control is a single bandpass filter with a 1 octave bandwidth designed to affect the frequency range between a bass control and a treble control, typically 500Hz-1000Hz. Again, the range

CHAPTER SEVEN

AUTOMATIC MICROPHONE SYSTEMS
AND SIGNAL PROCESSORS

of cut or boost is typically up to ± 15 dB. Bandpass filters have fixed frequency and fixed bandwidth.

Sets of multiple bandpass filters are used for more precise overall response shaping. When vertical slide controls are used for adjustment these are called *graphic equalizers* because the shape of the resulting response curve is visually approximated by the control positions. Graphic equalizers also have fixed frequency and fixed bandwidth. Typical variations are 1 octave (8-10 bands), 1/2 octave (12-15 bands), and 1/3 octave (27-31 bands). The narrower the bandwidth, the more filters are available and the more precise the adjustment capability.

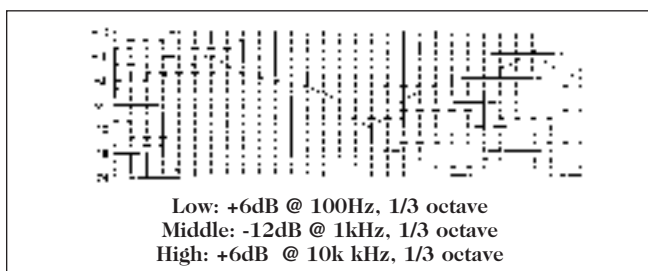

Graphic Equalizers

A set of bandpass filters whose frequency and bandwidth can also be adjusted is called a *parametric equalizer* because all of its “parameters” are adjustable. Parametric equalizers can be “tuned” to any desired frequency, adjusted to a suitable bandwidth, and boost or cut as needed. They typically have a frequency range of 20-20,000Hz, a bandwidth range of 1/10 to 2 octaves, and cut or boost of ± 15 dB. Most parametric equalizers have at least 3-5 independent filters, though some midrange controls on mixing consoles are actually a parametric filter. Parametric equalizers can provide very precise frequency response shaping.

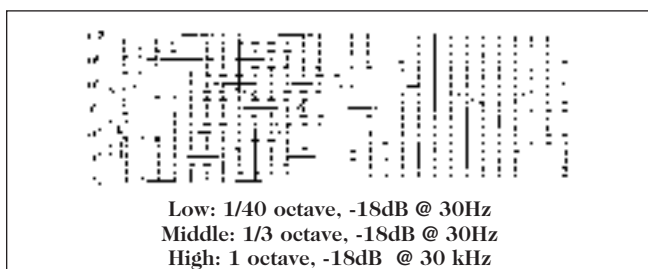

Parametric Equalizers

A special type of parametric filter is the “notch” filter. It has both variable frequency and bandwidth but is used in a “cut only” mode, typically down to -18dB. In addition, the bandwidth of some notch filters can be as narrow as 1/40 octave. Notch filters are the most useful filters for

feedback control because they allow precise attenuation at any frequency with minimal effect on adjacent frequencies. A number of notch filters can be activated with very little audible effect on overall sound quality.

Other equalizer types, even 1/3 octave graphics, have a very noticeable effect on sound quality due to the relatively large bandwidth of their filters, especially when adjacent filters are used to reduce an “in between” frequency. Similarly, use of hi-cut, lo-cut, or shelving equalizers for feedback control can result in severe loss of sound quality and is warranted only if the feedback is at an extremely high or low frequency.

FEEDBACK CONTROL

The use of an equalizer for feedback control is of course limited to the degree that the feedback is due to inequalities in system components or room acoustics. It cannot compensate for badly-located microphones and/or loudspeakers and certainly will not eliminate all possibility of feedback. Poorly-designed systems or unreasonable operating conditions can’t be fixed by even the most powerful equalizer. Nevertheless, judicious use of equalization can improve the feedback stability of a well-designed system and may even allow a marginal system to operate adequately.

The traditional approach to “ringing out” or equalizing a sound system for feedback problems is to gradually bring up the gain of the system until ringing or feedback begins, identify the offending frequency, and insert an appropriate filter until the feedback stops. The process is repeated until either the desired gain is reached (hopefully) or all the filters are used up. The most difficult steps are: identifying the feedback frequency and inserting the appropriate filter. Even very experienced sound engineers often have to rely on special equipment to pinpoint the feedback frequency. In addition, the use of parametric filters or notch filters is not very intuitive.

FEEDBACK CONTROLLERS

Recently, products called feedback controllers have become available which “automatically” identify and reduce feedback. They employ complex algorithms (mathematical modeling techniques) to identify sustained single frequency sounds and to deploy a notch filter of the correct frequency and attenuation. These devices typically have 5-10 filters that can be automatically set. The filters are narrow enough (1/10 octave) that their effect is not noticeable beyond the reduction of feedback. A bypass switch is usually provided to compare the equalized and un-equalized sound after the filters have been set.

CHAPTER SEVEN

AUTOMATIC MICROPHONE SYSTEMS
AND SIGNAL PROCESSORS

Some feedback controllers have other functions built-in. These may include other types of equalizers such as graphic or parametric, or other types of processors altogether such as limiters and time delays. Certain models offer computer interfaces for programming, external control, and monitoring.

Though none of these devices can anticipate feedback, they can still respond to the onset of feedback or ringing more quickly and accurately than most human operators. However, feedback controllers do not equalize the system for good sound, merely for least feedback. It is still up to the system designer and operator to insure the desired sound quality.

Within the limitations mentioned earlier, such automatic feedback controllers can be quite useful. They can be used on the main sound system, the monitor system, or even inserted on an individual channel. If the sound system is normally controlled by an operator, they can assist in the ringing out process. The operator merely continues to slowly turn up the system level until the major feedback frequencies have been identified and “notched” out. Alternately, the device can be left active to take care of feedback that may occur during unat-

tended system operation. When used properly, feedback controllers can improve gain-before-feedback by up to 6-10dB. Remember that more substantial improvements can often be made just by repositioning microphones or loudspeakers.



*Example of a PC-controlled feedback reducer and equalizer.
(Two Shure DFR11EQs shown on bottom of rack.)*

TYPICAL APPLICATIONS

In order to select a microphone for a specific application, it is first necessary to know the important characteristics of the sound source(s) and of the sound system. Once these are defined, a look at the five areas of microphone specifications previously discussed will lead to an appropriate match. Finally, correct placement and proper use will insure best performance. In this section, we will present recommendations for some of the most common worship facility sound applications. The sound system in the following examples is assumed to be of high quality, with balanced low-impedance microphone inputs and available phantom power.

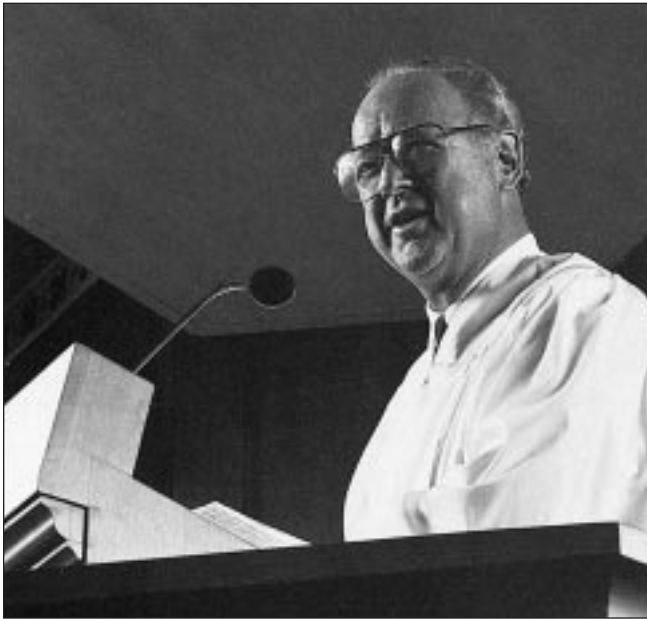

Lectern Application

Lectern

The desired sound source for a lectern microphone is typically a speaking voice, though one may occasionally be used for singing. Undesired sound sources that may be present are nearby loudspeakers (possibly a central cluster overhead), and ambient sound (possibly ventilation or traffic noise, and reflected sound).

The basic performance requirements for a lectern microphone can be met by either dynamic or condenser types, so the choice of operating principle is often determined by other factors, such as appearance. In particular, the desire for an unobtrusive microphone is better satisfied by a condenser design, which can maintain high performance even in very small sizes. Dynamic types are somewhat larger, but they do not require phantom power.

To match the desired sound source (the voice), the microphone must have a frequency response that covers the vocal range (approximately 100Hz to 15kHz). Within that range the response can be flat, if the sound system and the room acoustics are very good; but often a shaped response, with some presence rise, will improve intelligibility. Above 15kHz and below 100 Hz, the response should roll off smoothly, to avoid pickup of noise and other sounds outside of the vocal range, and to control proximity effect.

The choice of microphone directionality that will maximize pickup of the voice, and minimize undesired sounds, is unidirectional. This type will also reduce the likelihood of feedback since it can be aimed toward the talker and away from loudspeakers. Depending on how much the person speaking may move about, or on how close the microphone can be placed, a particular type may be chosen: a cardioid for moderately broad, close-up coverage; a supercardioid or a hypercardioid for progressively narrower or slightly more distant coverage.

The electrical characteristics of the microphone are primarily determined by the sound system: in this case a balanced low-impedance type would match the inputs on the mixer. Of course, this would be the desired choice in almost all systems due to the inherent benefits of lower noise and longer cable capability. Sufficient sensitivity for lectern use can be achieved by either condenser or full-size dynamic types, since the sound source is fairly strong and picked up from only a slight distance.

The physical design of a lectern microphone must blend performance with actual use. The most effective approach is a gooseneck-mounted type, which places the microphone close to the sound source and away from both the reflective surface of the lectern and noise from the handling of materials on it. Another approach is the use of a boundary microphone on the lectern surface, but this method is limited by lectern design and by the potential for noise pickup. As mentioned above, the desired physical design may also suggest the operating principle: the most effective small gooseneck or boundary styles are condensers.

The ideal placement of a lectern microphone is 8 to 16 inches away from the mouth, and aimed toward the mouth. This will guarantee good pickup of the voice and maximum rejection of unwanted sources. Locate the microphone a few inches off-center and below the mouth level. This will greatly reduce breath noise that occurs directly in front of the mouth but will still provide good coverage throughout the pickup angle of the microphone.

TYPICAL APPLICATIONS

If possible, adjust the sound system to provide stable operation with the lectern microphone at a nominal distance of 12 inches. This will provide relatively less change in level with changes in distance than if the microphone is placed much closer, due to the inverse-square law. For example, with a nominal distance of 12 inches a change of ± 6 inches results in a -3.5dB to +6dB level change. For a nominal distance of only 6 inches, the same distance change results in a -6dB to greater than +18dB level change, a much larger variation. The difference in potential acoustic gain between the two nominal positions is 6dB.

For proper operation, the microphone must be connected to the sound system with quality cables and connectors. The correct phantom power should be applied if a condenser microphone is used. Use a shock mount to control mechanical noise from the lectern itself. Some microphones are equipped with low-cut or low-end roll-off filters, which may further reduce low-frequency mechanical and acoustic noise. Goosenecks should be quiet when flexed. It is strongly recommended that a pop filter be placed on the microphone to control explosive breath sounds, especially when using miniature condenser types.

**GOOD TECHNIQUES FOR LECTERN
MICROPHONE USAGE INCLUDE:**

- Do adjust the microphone position for proper placement.
- Do maintain a fairly constant distance (8-16 inches).
- Don't blow on microphone, or touch microphone or mount, in use.
- Don't make excess noise with materials on lectern.
- Do speak in a clear and well-modulated voice.

Altar

The desired sound source for an altar application is a speaking (or sometimes singing) voice. Undesired sounds may include direct sounds, such as choir, organ, or loudspeakers and ambient noise sources, such as building noise or the congregation itself.



Altar Application

A boundary microphone is the physical design best suited to this application. Its use will minimize interference effects due to reflections from the altar surface and will also result in increased microphone reach. A condenser type is the most effective for this configuration, due to its high performance and small size.

The frequency response should be optimized for the vocal range and will benefit from a slight presence rise. A unidirectional (typically cardioid) pattern will give the broadest coverage with good rejection of feedback and noise. A condenser microphone will provide the highest sensitivity. Finally, the microphone should have a balanced low-impedance output.

**GOOD TECHNIQUES FOR
ALTAR MICROPHONE USAGE INCLUDE:**

- Do observe proper microphone placement.
- Do speak within coverage area of microphone.
- Don't make excess noise with materials on altar.
- Do project the voice, due to greater microphone distance.

TYPICAL APPLICATIONS

The microphone should be placed flat on the altar at a distance of 2 to 3 feet and aimed towards the normal position of the person speaking. It should be located or aimed away from other objects and from any local noise such as page turning. Unless there is more than one distinct position to be covered, and unless these positions do not violate the 3-to-1 rule, use only one altar microphone.

The microphone should be connected and powered (if a condenser) in the proper fashion. If the altar itself is a source of noise or vibration, isolate the microphone from it with a thin foam pad. A low-frequency filter may be a desirable or even necessary feature. A pop filter is not normally required. Do not cover the microphone with heavy altar linens.

Handheld Vocal

The desired sound source for a handheld microphone is a singing or speaking voice. Undesired sounds may include other singers, musical instruments, and various ambient sounds. In addition to the normal loudspeakers, the sound system may also have nearby “monitor” speakers aimed toward the singer.

Suitable microphone performance for this application can be provided by dynamics or condensers. Due to frequent handling and the potential for rough treatment, dynamic microphones are most often used, though durable condensers are available for high-performance applications. The preferred frequency response is

vocal range, with presence rise for intelligibility and low-frequency roll-off for control of proximity effect and handling noise. These microphones should always be unidirectional: a cardioid pattern is most common, while supercardioid and hypercardioid types may be used in difficult noise or feedback situations.



Handheld Vocal Application

Balanced, low-impedance output configuration is standard, while adequate sensitivity may be achieved with dynamic or condenser types. Finally, the physical design is optimized for comfortable handheld use, and generally includes an integral windscreen/pop filter and an internal shock mount. An on-off switch may be desirable in some situations.

Positioning a handheld microphone at a distance of 4 to 12 inches from the mouth (and aimed towards it) will give good pickup of the voice. In addition, locating the microphone slightly off-center, but angled inward, will reduce breath noise.

With high levels of sound from adjacent musical instruments or other singers, it may be necessary to hold the microphone closer to the mouth. If the distance is very short, especially less than 4 inches, proximity effect will greatly increase the low-frequency response. Though this may be desirable for many voices, a low-frequency roll-off may be needed to avoid a boomy sound. Additional pop filtering may also be required for very close use.

Use of rugged, flexible cables with reliable connectors is an absolute necessity with handheld microphones. A stand or holder should also be provided if it is desirable to use the microphone hands-free.

GOOD TECHNIQUES FOR HANDHELD MICROPHONE USAGE INCLUDE:

- Do hold microphone at proper distance for balanced sound.
- Do aim microphone toward mouth and away from other sound sources.
- Do use low frequency roll-off to control proximity effect.
- Do use pop filter to control breath noise.
- Don't create noise by excessive handling.
- Do control dynamics with voice rather than moving microphone.

TYPICAL APPLICATIONS

Lavalier

The desired sound source for a lavalier microphone is a speaking (or occasionally singing) voice. Undesired sources include other speaking voices, clothing or movement noise, ambient sound, and loudspeakers.



Lavalier Application

A condenser lavalier microphone will give excellent performance in a very small package, though a dynamic may be used if phantom power is not available or if the size is not critical. Lavalier microphones have a specially shaped frequency response to compensate for off-axis placement (loss of high frequencies), and sometimes for chest “resonance” (boost of middle frequencies). The most common polar pattern is omnidirectional, though unidirectional types may be used to control excessive ambient noise or severe feedback problems. However, unidirectional types have inherently greater sensitivity to breath and handling noise.

Balanced low-impedance output is preferred as usual. Adequate sensitivity can be achieved by both dynamic and condenser types, due to the relatively close placement of the microphone. However, a condenser is generally preferred. The physical design is optimized for body-worn use. This may be done by means of a clip, a pin, or a neck cord. Small size is very desirable. For a condenser, the necessary electronics are often housed in a separate small pack, also capable of being worn or placed in a pocket. Some condensers incorporate the electronics directly into the microphone connector. Provision must also be made for attaching or routing the cable to allow mobility for the user.

Placement of lavalier microphones should be as close to the mouth as is practical, usually just below the neckline on a lapel, a tie, or a lanyard, or at the neckline in the case of robes or other vestments. Omnidirectional types may be oriented in any convenient way, but a unidirectional type must be aimed in the direction of the mouth.

Avoid placing the microphone underneath layers of clothing or in a location where clothing or other objects may touch or rub against it. This is especially critical with unidirectional types. Locate and attach the cable to minimize pull on the microphone and to allow walking without stepping or tripping on it. A wireless lavalier system eliminates this problem and provides complete freedom of movement. Again, use only high-quality cables and connectors, and provide phantom power if required.

GOOD TECHNIQUES FOR LAVALIER MICROPHONE USAGE INCLUDE:

- Do observe proper placement and orientation.
- Do use pop filter if needed, especially with unidirectional.
- Don't breathe on or touch microphone or cable.
- Don't turn head away from microphone.
- Do mute lavalier when using lectern or altar microphone.
- Do speak in a clear and distinct voice.

Choir

The desired sound source is a group of singing voices. Undesired sound sources may include the organ or other musical instruments, loudspeakers, and various ambient noise.

A condenser is the type of microphone most often used for choir application. They are generally more capable of flat, wide-range frequency response. The most appropriate directional type is a unidirectional, usually a cardioid. A supercardioid or a hypercardioid microphone may be used for slightly greater reach or for more ambient sound rejection. Balance low-impedance output is used exclusively, and the sensitivity of a condenser microphone is desirable because of the greater distance between the sound source and the microphone.

TYPICAL APPLICATIONS



Choir Application

The physical design of the microphone for choir pickup should lend itself to some form of overhead mounting. It may be supported by its own cable or by some other fixture, such as a stereo microphone mount. Finally, it may be a full-size microphone or a miniature type for unobtrusive placement.

Application of choir microphones falls into the category known as area coverage. Rather than one microphone per sound source, the object is to pick up multiple sound sources (or a large sound source) with one (or more) microphone(s). Obviously, this introduces the possibility of interference effects unless certain basic principles (such as the “3-to-1 rule”) are followed, as discussed below.

For one microphone picking up a typical choir, the suggested placement is a few feet in front of, and a few feet above, the heads of the first row. It should be centered in front of the choir and aimed at the last row. In this configuration, a cardioid microphone can cover up to 15-20 voices, arranged in a rectangular or wedge-shaped section.

For larger or unusually shaped choirs, it may be necessary to use more than one microphone. Since the pickup angle of a microphone is a function of its directionality (approximately 130 degrees for a cardioid), broader coverage requires more distant placement. As choir size increases, it will eventually violate the cardinal rule: place the microphone as close as practical to the sound source.

In order to determine the placement of multiple microphones for choir pickup, remember the following rules: **observe the 3-to-1 rule; avoid picking up the same sound source with more than one microphone; and finally, use the minimum number of microphones.**

For multiple microphones, the objective is to divide the choir into sections that can each be covered by a single microphone. If the choir has any existing physical divisions (aisles or boxes), use these to define basic sections. If the choir is grouped according to vocal range (soprano, alto, tenor, bass), these may serve as sections.

TYPICAL APPLICATIONS

If the choir is a single, large entity, and it becomes necessary to choose sections based solely on the coverage of the individual microphones, use the following spacing: one microphone for each lateral section of approximately 8 to 12 feet. If the choir is unusually deep (more than 6 or 8 rows), it may be divided into two vertical sections of several rows each, with aiming angles adjusted accordingly. In any case, it is better to use too few microphones than too many.

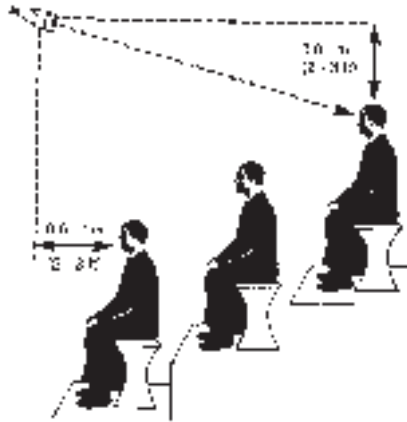

Microphone Positions - Side View

GOOD TECHNIQUES FOR
CHOIR MICROPHONE USAGE INCLUDE:

- Do place the microphones properly.
- Do use the minimum number of microphones.
- Do turn down unused microphones.
- Do let the choir naturally “mix” itself.
- Don’t “over-amplify” the choir.
- Don’t sing “at” the microphone.
- Do sing in a natural voice.

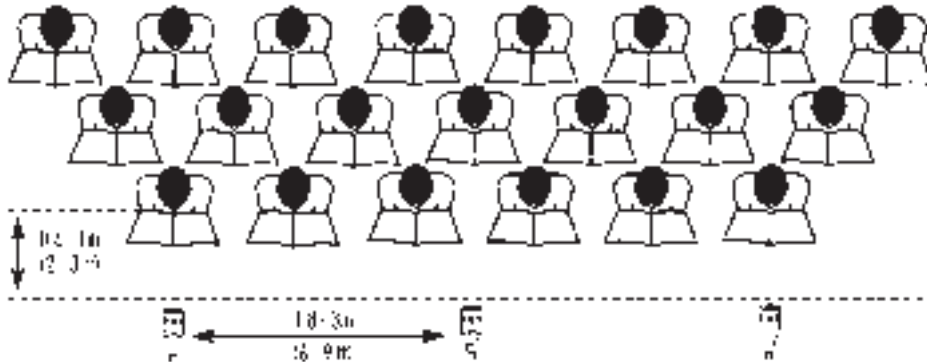

Choir Microphone Positions - Top View

It is very important to locate choir microphones as far away from loudspeakers as possible. Be aware of the rear pickup of supercardioid and hypercardioid types when aiming microphones. Try to avoid pickup of organ pipes or speakers in the choir loft. And, of course, keep microphones away from other noise sources such as air ducts.

Once overhead microphones are positioned, and the cables have been allowed to stretch out, they should be secured, if necessary, to prevent turning or other movement by air currents or temperature changes. Fine thread or fishing line will accomplish this with minimum visual impact. Use only the highest-quality cables and connectors, particularly if miniature types are specified.

The use of choir microphones is governed, to some extent,

by the intended destination of the sound. In general, high-level sound reinforcement of a choir within the main body of the worship facility is not recommended. In fact, it is not possible in most cases, unless the choir itself is isolated from the main body of the worship facility. Use of area pickup microphones in the same acoustic space as area coverage loudspeakers results in severe limitations on gain-before-feedback. The best that can be done in this circumstance is low-level reinforcement in the immediate area, and, possibly, medium-level reinforcement to distant areas, such as under balconies or in foyers. Destinations such as isolated listening areas, recording equipment, or broadcast audiences can receive higher levels because feedback is not a factor in these locations.

Many older worship facilities are very reverberant spaces, which provide natural, acoustic reinforcement for the choir, though sometimes at the expense of speech intelligibility. Some modern architecture has been designed to provide a less reverberant space, both for greater speech intelligibility and to accommodate modern forms of music. This results in a greater reliance on electronic reinforcement. However, it is still not practical (and probably not aesthetically advisable) to make a choir of 20 sound like a choir of 200. The sound system (and the microphones) can provide some useful enhancement, but a large acoustically dead worship facility simply requires a large live choir.

TYPICAL APPLICATIONS

Congregation

The desired sound source for a congregation microphone is a group of speaking or singing voices. Undesired sources are usually the sound system loudspeakers and various ambient sounds.

Condensers are the choice for highest-quality sound at a distance. A flat, vocal-range frequency response is usually desirable, with a unidirectional polar pattern to minimize pickup of unwanted sound. The electrical output should be balanced low-impedance, and the physical design should accommodate overhead mounting, by cable or other fixture. The microphone may be either full-size or miniature, depending on visual requirements.

Since this application of microphones is another example of area coverage, the placement should be in front of, above, and aimed toward the faces of the congregation. Though similar in concept to the choir example, fewer and more distant microphones may be used to pick up the overall ambience of the congregation.

A particular method that is sometimes suggested for overhead placement is a ceiling-mounted microphone, usually a boundary microphone. This position should be used with caution, for two reasons: first, it often places the microphone too far from the desired sound source, especially in the case of a high ceiling. Second, the ceiling, in buildings of modern construction, is often an extremely noisy location, due to air handling noise, lighting fixtures, and building vibration. Remember that a microphone does not “reach out” and “capture” sound: it can only respond to the sound in its immediate vicinity. If this local soundfield is louder than the distant sound from below, there is no hope of picking up a usable sound with a ceiling-mounted microphone.

Congregation area microphones are used exclusively for recording, broadcast, and other isolated destinations. It is never intended to be mixed into the sound system for local reinforcement. If it is desired to reinforce an individual member of the congregation, it can only be done successfully with an individual microphone in the congregation: a stand-mounted type that the member can approach or a handheld type (wired or wireless) that can be passed to the member.

GOOD TECHNIQUES FOR CONGREGATION MICROPHONES INCLUDE:

- All the techniques for “Choir Microphone Usage” (see previous page).

PLUS:

- Do use only at a level sufficient to add ambience to a recording.
- Don't mix area microphones into the sound reinforcement system.

Musical Instruments

A tremendous variety of musical instruments is used in current worship facility services. In fact, almost any instrument that exists may be used: from classical symphonic instruments, to modern electronic instruments, to historical and ethnic instruments of any description. Presented here will be techniques for three musical instruments that are widely used today: the acoustic guitar, the piano, and the organ. Use of microphones with many other instruments is discussed in Shure's *Guides to Microphone Techniques* (AL1265 and AL1266). See back cover for more details on ordering these publications.



Piano and Guitar Application

In each of these examples, the desired sound source is the musical instrument itself. Possible undesired sound sources include other nearby instruments, singers, loudspeakers, and the usual ambient noise sources.

TYPICAL APPLICATIONS

Since accurate, wide-range reproduction of musical instruments is the goal, the use of condenser microphones is often preferred, although certain instruments, such as drums, can be well suited to dynamic types. The frequency response is usually flat and wide-range, especially for organ or piano. Unidirectional designs are preferable, to minimize pickup of undesired sound. Again, balanced low-impedance models are the best choice. Because close microphone placement is used, dynamic and condenser types have suitable sensitivity for general sound reinforcement. However, condensers are recommended for highest-quality sound. The physical design, though, can vary widely in instrument applications, depending on the desired placement and use.

GOOD TECHNIQUES FOR AN ACOUSTIC INSTRUMENT MICROPHONE USAGE INCLUDE:

- Do experiment with placement for best sound.
- Do maintain a constant distance.
- Do use a shock mount if stage noise is present.
- Don't position microphone where it may be struck by instrument.
- Don't allow voice to be picked up by instrument microphone.

ACOUSTIC GUITAR

The acoustic guitar is a relatively small sound source that can normally be picked up quite well by only one microphone. Since most of the sound comes from the sound hole and the top of the guitar, a microphone positioned in front of the guitar can get an excellent overall sound. This sound will vary, however, as a function of the microphone distance from the sound hole and its orientation to the top of the guitar.



Guitar Application

The sound will be louder and “bassier” the closer to the sound hole; softer and thinner farther away. Proximity effect will also increase the bass response at close distances.

A full-size microphone can be positioned on a stand to give the desired sound. An alternate approach is to mount a miniature microphone directly on (or in) the guitar by means of a clip or holder. This keeps the microphone at a constant distance, and allows freedom of movement for the performer, especially if used with a wireless transmitter. In either case, care must be taken to position the microphone to avoid interfering with the player.

PIANO

The piano is a relatively large acoustic source whose sound comes from the soundboard, the strings, and reflections from the lid and other body parts. Although the piano is normally heard at a distance, it is not feasible to use a distant microphone on a piano for sound reinforcement, due to gain-before-feedback limitations. Placing the microphone close to or inside of the piano is the normal procedure. The resulting sound is not entirely natural, but careful microphone placement can yield very good results.



Piano Application

Depending on placement, several microphone physical designs may be used. A conventional, full-size microphone can be positioned close to or inside of the piano (with the lid open) using a stand and boom. A position over the treble strings will yield a bright sound while a position over the middle or low strings will correspond to a bassier sound. A sharper attack is heard near the hammers, while a softer sound is heard farther away. For greater isolation from other sounds and to reduce feedback, a boundary microphone is sometimes attached to the underside of the lid, which is then partially or completely closed.

Since very close microphone placement may not pick up the full sound of a large source, it is sometimes desirable to use two (or more) microphones, especially for stereo reproduction. In this case, microphone placement becomes more subjective due to the possibility of interference effects. A good starting point is one microphone over the treble strings and a second over the bass strings. This will often produce a more balanced sound, and does allow a greater range of control. However, some experimentation will be necessary to get the best sound from a specific instrument in a specific room.

TYPICAL APPLICATIONS

GOOD TECHNIQUES FOR PIANO MICROPHONE USAGE INCLUDE:

- Do experiment with placement for best sound.
- Do adjust lid for best sound and/or isolation.
- Do use shock mounts if vibration is a problem.
- Do listen for interference effects with multiple microphones.
- Don't allow voice to be picked up by instrument microphone.

ORGAN

The organ is potentially the largest sound source in some worship facility applications. However, pipe organs and large electronic organs are not normally reinforced by sound systems, but rather are picked up for recording or broadcast purposes. Since the organ is also the widest range instrument, the careful placement of high-quality microphones is essential for best results.

A large organ produces sound from many ranks of pipes, or, for an electronic type, from a number of tone cabinets. Since it is not possible to use microphones on individual pipes or loudspeakers, some type of area coverage must be employed. Often, the groups of pipes or tone cabinets are widely separated, sometimes even located on opposite sides of the worship facility, as is the case with antiphonal ranks. This will require a decision on the goal of the sound.

If the goal is to reproduce the sound as heard by a listener in the house of worship, one or two (for stereo) microphones can be positioned in the body of the worship facility, over the congregation, and aimed toward the main organ ranks. This will pick up a representative organ sound, with a high proportion of room sound (ambient sound), as well as the sound from the choir and from the sound system itself. If the room has reasonably good acoustics, and if the level of the organ is well-balanced with both the choir and the sound system, this is the simplest and most effective way to simulate being in the religious facility. In some arrangements, the choir microphones themselves will pick up a suitable organ sound.

On the other hand, if the goal is to reproduce a concert organ performance that does not rely heavily on the room acoustics, or if it is desired to control the level of

the organ independently of the choir and other sounds, it is necessary to place microphones to pick up the organ sound only. This will require that a microphone be placed close enough to each of the main locations of pipes or tone cabinets so that the microphone hears primarily the local organ sound, rather than the ambient or room sound.

This may involve several microphones, depending on the number and location of sound sources. Individual placement should be done according to the guidelines given earlier with respect to choir pickup, although it may be possible to mount microphones on stands in organ galleries as well as overhead in front of exposed ranks. In any case, some experimentation with microphone positioning, and careful mixing of microphone signals will be necessary to get a full, balanced sound.

Non-Sanctuary Applications

Today, the life of worship facilities extends far beyond the sanctuary, in the form of classes, meetings, plays, social events, and fund-raising activities, both indoors and out. Even the weekly service may not always be held in the same location. Sound systems can play an important role in all of these situations. While it is not possible to detail microphone techniques for every application, a few examples will show how to use some of the ideas already presented.

Though most classrooms are not large enough to require the use of a sound system, it is sometimes necessary to record a class, or to hold a very large class in an auditorium. In these cases, it is suggested that the teacher wear a wireless lavalier microphone to allow freedom of movement and to maintain consistent sound quality. If it is desired to pick up the responses of students, it is possible to use area microphones in a recording application, but not with a sound system. A better technique is to present questions at a fixed stand microphone, or to pass a wired or wireless handheld microphone to the student.

Meetings and conferences often involve a large number of microphones in the same room. Use unidirectional types, dynamic or condenser, and locate them as close to the participants as practical. Observe the 3-to-1 rule and use as few microphones as necessary. Usually, one microphone can cover two people. Boundary types are very useful on tables if tabletop noise is low, otherwise conventional types on short stands or goosenecks should be used. Turn up microphones only as needed. Due to the potential for feedback, noise and interference from multiple microphones, it is suggested that an automatic microphone mixing system be considered.

TYPICAL APPLICATIONS

Microphone use for plays and other theatrical events involves both individual and area coverage. Professional productions usually employ wireless microphones for all the principle actors. This requires a complete system (microphone, transmitter, receiver) for each person, and the frequencies must be selected so that all systems will work together without interference. While it is possible to purchase or rent a large number of wireless systems, it is often more economical to combine just a few wireless systems with area microphones for the rest of the players. Use unidirectional boundary microphones for “downstage” (front) pickup and unidirectional overhead microphones for “upstage” (rear) pickup. Always use a center microphone, because most action occurs at center stage. Use flanking microphones to cover side areas but observe the 3-to-1 rule and avoid overlapping coverage. Turn up microphones only as needed.

Social events, such as dances or carnivals, generally require only PA (public address) coverage. Use unidirectional, handheld or stand mounted microphones. A dynamic type is an excellent choice, because of its rugged design. The microphone should be equipped with an on-off switch if it is not possible to turn down the microphone channel on the sound system. In any case, turn up the microphone(s) only as needed.

A typical fund-raising activity is the bingo game. Again, only PA coverage is needed. A unidirectional, dynamic microphone mounted on a stand works very well in this application. Alternatively, the caller may choose a lavalier or headworn type to permit freedom of movement. A convenient addition is a handheld wireless microphone for the person who verifies the cards in the audience.

Outdoor use of microphones is, in some ways, less difficult than indoor. Sound outdoors is not reflected by walls and ceilings, so reverberation is not present. Without reflected sound, the potential for feedback is also

reduced. However, the elements of nature must be considered: wind, sun, and rain. Because of these factors, dynamic types are most often used, especially in the likelihood of rain. In any case, adequate windscreens are a must. Microphone principles are the same outdoors, so unidirectional patterns are still preferred. Finally, because of frequent long cable runs outdoors, balanced low-impedance models are always recommended.

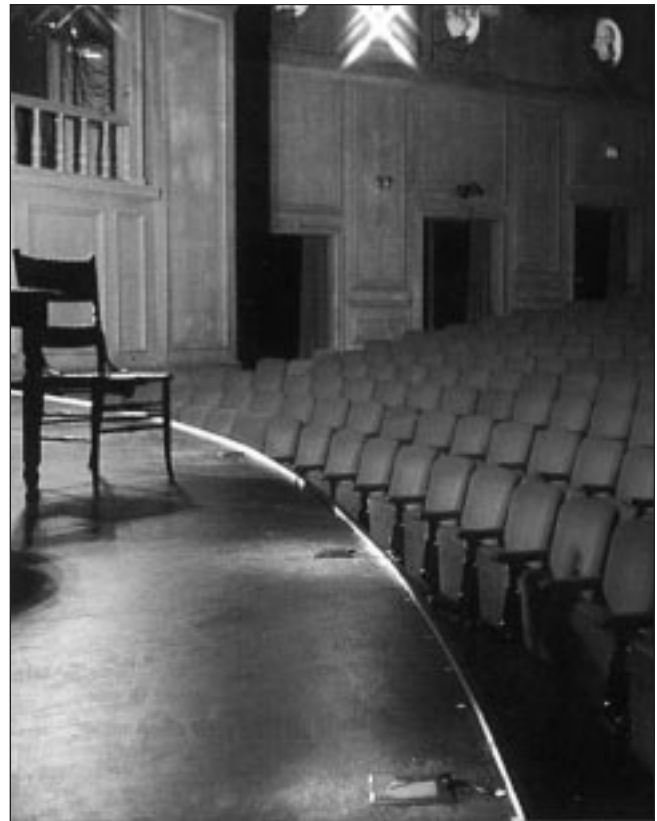

Example of unidirectional boundary microphones being used to provide area coverage for an on-stage application.

GLOSSARY

3-to-1 Rule - When using multiple microphones, the distance between microphones should be at least 3 times the distance from each microphone to its intended sound source.

Absorption - The dissipation of sound energy by losses due to sound absorbent materials.

Active Circuitry - Electrical circuitry which requires power to operate, such as transistors and vacuum tubes.

Ambience - Room acoustics or natural reverberation.

Amplitude - The strength or level of sound pressure or voltage.

Audio Chain - The series of interconnected audio equipment used for recording or PA.

Backplate - The solid conductive disk that forms the fixed half of a condenser element.

Balanced - A circuit that carries information by means of two equal but opposite polarity signals, on two conductors.

Bidirectional Microphone - A microphone that picks up equally from two opposite directions. The angle of best rejection is 90 degrees from the front (or rear) of the microphone, that is, directly at the sides.

Boundary/Surface Microphone - A microphone designed to be mounted on an acoustically reflective surface.

Cardioid Microphone - A unidirectional microphone with moderately wide front pickup (131 degrees). Angle of best rejection is 180 degrees from the front of the microphone, that is, directly at the rear.

Cartridge (Transducer) - The element in a microphone that converts acoustical energy (sound) into electrical energy (the signal).

Clipping Level - The maximum electrical output signal level (dBV or dBu) that the microphone can produce before the output becomes distorted.

Close Pickup - Microphone placement within 2 feet of a sound source.

Comb Filtering - An interference effect in which the frequency response exhibits regular deep notches.

Condenser Microphone - A microphone that generates an electrical signal when sound waves vary the spacing between two charged surfaces: the diaphragm and the backplate.

Critical Distance - In acoustics, the distance from a sound source in a room at which the direct sound level is equal to the reverberant sound level.

Current - Charge flowing in an electrical circuit. Analogous to the amount of a fluid flowing in a pipe.

Decibel (dB) - A number used to express relative output sensitivity. It is a logarithmic ratio.

Diaphragm - The thin membrane in a microphone which moves in response to sound waves.

Diffraction - The bending of sound waves around an object which is physically smaller than the wavelength of the sound.

Direct Sound - Sound which travels by a straight path from a sound source to a microphone or listener.

Distance Factor - The equivalent operating distance of a directional microphone compared to an omnidirectional microphone to achieve the same ratio of direct to reverberant sound.

Distant Pickup - Microphone placement farther than 2 feet from the sound source.

Dynamic Microphone - A microphone that generates an electrical signal when sound waves cause a conductor to vibrate in a magnetic field. In a moving-coil microphone, the conductor is a coil of wire attached to the diaphragm.

Dynamic Range - The range of amplitude of a sound source. Also, the range of sound level that a microphone can successfully pick up.

Echo - Reflection of sound that is delayed long enough (more than about 50 msec.) to be heard as a distinct repetition of the original sound.

Electret - A material (such as Teflon) that can retain a permanent electric charge.

EQ - Equalization or tone control to shape frequency response in some desired way.

Feedback - In a PA system consisting of a microphone, amplifier, and loudspeaker, feedback is the ringing or howling sound caused by amplified sound from the loudspeaker entering the microphone and being re-amplified.

Flat Response - A frequency response that is uniform and equal at all frequencies.

GLOSSARY

Frequency - The rate of repetition of a cyclic phenomenon such as a sound wave.

Frequency Response Tailoring Switch - A switch on a microphone that affects the tone quality reproduced by the microphone by means of an equalization circuit. (Similar to a bass or treble control on a hi-fi receiver.)

Frequency Response - A graph showing how a microphone responds to various sound frequencies. It is a plot of electrical output (in decibels) vs. frequency (in Hertz).

Fundamental - The lowest frequency component of a complex waveform such as musical note. It establishes the basic pitch of the note.

Gain - Amplification of sound level or voltage.

Gain-Before-Feedback - The amount of gain that can be achieved in a sound system before feedback or ringing occurs.

Gobos - Movable panels used to reduce reflected sound in the recording environment.

Harmonic - Frequency components above the fundamental of a complex waveform. They are generally multiples of the fundamental which establish the timbre or tone of the note.

Hypercardioid - A unidirectional microphone with tighter front pickup (105 degrees) than a supercardioid, but with more rear pickup. Angle of best rejection is about 110 degrees from the front of the microphone.

Impedance - In an electrical circuit, opposition to the flow of alternating current, measured in ohms. A high-impedance microphone has an impedance of 10,000 ohms or more. A low-impedance microphone has an impedance of 50 to 600 ohms.

Interference - Destructive combining of sound waves or electrical signals due to phase differences.

Inverse Square Law - States that direct sound levels increase (or decrease) by an amount proportional to the square of the change in distance.

Isolation - Freedom from leakage; the ability to reject unwanted sounds.

Leakage - Pickup of an instrument by a microphone intended to pick up another instrument. Creative leakage is artistically favorable leakage that adds a "loose" or "live" feel to a recording.

Maximum Sound Pressure Level - The maximum acoustic input signal level (dB SPL) that the microphone can accept before clipping occurs.

NAG - Needed Acoustic Gain is the amount of gain that a sound system must provide for a distant listener to hear as if he or she was close to the unamplified sound source.

Noise - Unwanted electrical or acoustic energy.

Noise Cancelling - A microphone that rejects ambient or distant sound.

NOM - Number of open microphones in a sound system. Decreases gain-before-feedback by 3dB every time NOM doubles.

Omnidirectional Microphone - A microphone that picks up sound equally well from all directions.

Output Noise (Self-Noise) - The amount of residual noise (dB SPL) generated by the electronics of a condenser microphone.

Overload - Exceeding the signal level capability of a microphone or electrical circuit.

PAG - Potential Acoustic Gain is the calculated gain that a sound system can achieve at or just below the point of feedback.

Phantom Power - A method of providing power to the electronics of a condenser microphone through the microphone cable.

Phase - The "time" relationship between cycles of different waves.

Pickup Angle/Coverage Angle - The effective arc of coverage of a microphone, usually taken to be within the 3dB down points in its directional response.

Pitch - The fundamental or basic frequency of a musical note.

Polar Pattern (Directional Pattern, Polar Response) - A graph showing how the sensitivity of a microphone varies with the angle of the sound source, at a particular frequency. Examples of polar patterns are unidirectional and omnidirectional.

Polarization - The charge or voltage on a condenser microphone element.

Pop Filter - An acoustically transparent shield around a microphone cartridge that reduces popping sounds. Often a ball-shaped grille, foam cover or fabric barrier.

GLOSSARY

Pop - A thump of explosive breath sound produced when a puff of air from the mouth strikes the microphone diaphragm. Occurs most often with “p”, “t”, and “b” sounds.

Presence Peak - An increase in microphone output in the “presence” frequency range of 2,000 Hz to 10,000 Hz. A presence peak increases clarity, articulation, apparent closeness, and “punch.”

Proximity Effect - The increase in bass occurring with most unidirectional microphones when they are placed close to an instrument or vocalist (within 1 foot). Does not occur with omnidirectional microphones.

Rear Lobe - A region of pickup at the rear of a supercardioid or hypercardioid microphone polar pattern. A bidirectional microphone has a rear lobe equal to its front pickup.

Reflection - The bouncing of sound waves back from an object or surface which is physically larger than the wavelength of the sound.

Refraction - The bending of sound waves by a change in the density of the transmission medium, such as temperature gradients in air due to wind.

Resistance - The opposition to the flow of current in an electrical circuit. It is analogous to the friction of fluid flowing in a pipe.

Reverberation - The reflection of a sound a sufficient number of times that it becomes non-directional and persists for some time after the source has stopped. The amount of reverberation depends on the relative amount of sound reflection and absorption in the room.

Rolloff - A gradual decrease in response below or above some specified frequency.

Sensitivity - A rating given in dBV to express how “hot” the microphone is by exposing the microphone to a specified sound field level (typically either 94 dB SPL or 74 dB SPL). This specification can be confusing because manufacturers designate the sound level different ways. Here is an easy reference guide: 94 dB SPL = 1 Pascal = 10 microbars. To compare a microphone that has been measured at 74 dB SPL with one that has been measured at 94 dB SPL, simply add 20 to the dBV rating.

Shaped Response - A frequency response that exhibits significant variation from flat within its range. It is usually designed to enhance the sound for a particular application.

Signal to Noise Ratio - The amount of signal (dBV) above the noise floor when a specified sound pressure level is applied to the microphone (usually 94 dB SPL).

Sound Chain - The series of interconnected audio equipment used for recording or PA.

Sound Reinforcement - Amplification of live sound sources.

Speed of Sound - The speed of sound waves, about 1130 feet per second in air.

SPL - Sound Pressure Level is the loudness of sound relative to a reference level of 0.0002 microbars.

Standing Wave - A stationary sound wave that is reinforced by reflection between two parallel surfaces that are spaced a wavelength apart.

Supercardioid Microphone - A unidirectional microphone with tighter front pickup angle (115 degrees) than a cardioid, but with some rear pickup. Angle of best rejection is 126 degrees from the front of the microphone, that is, 54 degrees from the rear.

3-to-1 Rule - (See top of page 47.)

Timbre - The characteristic tone of a voice or instrument; a function of harmonics.

Transducer - A device that converts one form of energy to another. A microphone transducer (cartridge) converts acoustical energy (sound) into electrical energy (the audio signal).

Transient Response - The ability of a device to respond to a rapidly changing input.

Unbalanced - A circuit that carries information by means of one signal on a single conductor.

Unidirectional Microphone - A microphone that is most sensitive to sound coming from a single direction in front of the microphone. Cardioid, supercardioid, and hypercardioid microphones are examples of unidirectional microphones.

Voice Coil - Small coil of wire attached to the diaphragm of a dynamic microphone.

Voltage - The potential difference in an electric circuit. Analogous to the pressure on fluid flowing in a pipe.

Wavelength - The physical distance between the start and end of one cycle of a soundwave.

APPENDIX ONE: THE DECIBEL

The decibel (dB) is an expression often used in electrical and acoustic measurements. The decibel is a number that represents a ratio of two values of a quantity such as voltage. It is actually a logarithmic ratio whose main purpose is to scale a large measurement range down to a much smaller and more useable range. The form of the decibel relationship for voltage is:

$$\text{dB} = 20 \times \log(V1/V2)$$

where 20 is a constant, V1 is one voltage, V2 is a reference voltage, and log is logarithm base 10.

Examples:

What is the relationship in decibels between 100 volts and 1 volt? (dBV)

$$\text{dB} = 20 \times \log(100/1)$$

$$\text{dB} = 20 \times \log(100)$$

$$\text{dB} = 20 \times 2 \text{ (the log of 100 is 2)}$$

$$\text{dB} = 40$$

That is, 100 volts is 40dB greater than 1 volt.

What is the relationship in decibels between .0001 volt and 1 volt? (dBV)

$$\text{dB} = 20 \times \log(.0001/1)$$

$$\text{dB} = 20 \times \log(.0001)$$

$$\text{dB} = 20 \times (-3) \text{ (the log of .0001 is -3)}$$

$$\text{dB} = -60$$

That is, .0001 volt is 60dB less than 1 volt.

Similarly:

If one voltage is equal to the other, they are 0dB different.

If one voltage is twice the other, they are 6dB different.

If one voltage is ten times the other, they are 20dB different.

Since the decibel is a ratio of two values, there must be an explicit or implicit reference value for any measurement given in dB. This is usually indicated by a suffix on the dB. Some devices are measured in dBV (reference to 1 Volt = 0 dBV), while others may be specified in dBu or dBm (reference to .775V = 0dBu/dBm). Here is a chart that makes conversion for comparison easy:

Volts	dBV	dBu/dBm
100	+40.0	+42.2
10	+20.0	+22.2
1	0	0
0.1	-20.0	-17.8
0.01	-40.0	-37.8
0.001	-60.0	-57.8
0.0001	-80.0	-77.8
0.00001	-100.0	-97.8
0.000001	-120.0	-117.8
0.0000001	-140.0	-137.8

Conversion: dBm to dBu	dBm - 0.8 = dBu
dBu to dBm	dBu + 0.8 = dBm
Conversion: dBV to dBu	dBV - 2.2 = dBu
dBu to dBV	dBu + 2.2 = dBV

Conversion: dBu to dBm	dBu + 0.8 = dBm
dBm to dBu	dBm - 0.8 = dBu
Conversion: dBV to dBm	dBV + 2.2 = dBm
dBm to dBV	dBm - 2.2 = dBV

Conversion Chart

Audio equipment signal levels are generally broken into 3 main categories: Mic, Line, or Speaker Level. Aux level resides within the lower half of line level. The chart also shows at what voltages these categories exist.

One reason that the decibel is so useful in certain audio measurements is that this scaling function closely approximates the behavior of human hearing sensitivity. For example, a change of 1dB SPL is about the smallest difference in loudness that can be perceived while a 3dB SPL change is generally noticeable. A 6dB SPL change is quite noticeable and finally, a 10dB SPL change is perceived as twice as loud.

APPENDIX TWO: POTENTIAL ACOUSTIC GAIN

Potential Acoustic Gain (PAG) vs. Needed Acoustic Gain (NAG)

The basic purpose of a sound reinforcement system is to deliver sufficient sound level to the audience so that they can hear and enjoy the performance throughout the listening area. As mentioned earlier, the amount of reinforcement needed depends on the loudness of the instruments or performers themselves and the size and acoustic nature of the venue. This Needed Acoustic Gain (NAG) is the amplification factor necessary so that the furthest listeners can hear as if they were close enough to hear the performers directly.

To calculate NAG: $NAG = 20 \times \log (Df/Dn)$

Where: Df = distance from sound source to furthest listener

Dn = distance from sound source to nearest listener

log = logarithm to base 10

Note: the sound source may be a musical instrument, a vocalist or perhaps a loudspeaker

The equation for NAG is based on the inverse-square law, which says that the sound level decreases by 6dB each time the distance to the source doubles. For example, the sound level (without a sound system) at the first row of the audience (10 feet from the stage) might be a comfortable 85dB. At the last row of the audience (80 feet from the stage) the level will be 18dB less or 67dB. In this case the sound system needs to provide 18dB of gain so that the last row can hear at the same level as the first row. The limitation in real-world sound systems is not how loud the system can get with a recorded sound source but rather how loud it can get with a microphone as its input. The maximum loudness is ultimately limited by acoustic feedback.

The amount of gain-before-feedback that a sound reinforcement system can provide may be estimated mathematically. This Potential Acoustic Gain involves the distances between sound system components, the number of open mics, and other variables. The system will be sufficient if the calculated Potential Acoustic Gain (PAG) is equal to or greater than the Needed Acoustic Gain (NAG). Following is an illustration showing the key distances.

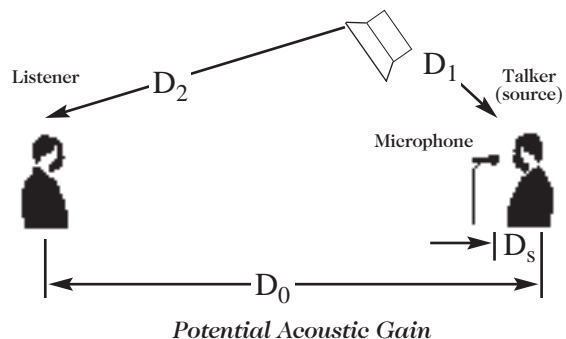

The simplified PAG equation is:

$$PAG = 20 (\log D1 - \log D2 + \log D0 - \log Ds) - 10 \log NOM - 6$$

Where: PAG = Potential Acoustic Gain (in dB)

Ds = distance from sound source to microphone

D0 = distance from sound source to furthest listener

D1 = distance from microphone to nearest loudspeaker

D2 = distance from loudspeaker to furthest listener

NOM = the number of open microphones

-6 = a 6 dB feedback stability margin

log = logarithm to base 10

In order to make PAG as large as possible, that is, to provide the maximum gain-before-feedback, the following rules should be observed:

- 1) Place the microphone as close to the sound source as practical.
- 2) Keep the microphone as far away from the loudspeaker as practical.
- 3) Place the loudspeaker as close to the audience as practical.
- 4) Keep the number of microphones to a minimum.

APPENDIX TWO: POTENTIAL ACOUSTIC GAIN

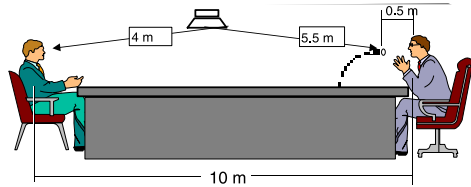

$$D_1 = 5.5 \text{ m} \quad D_2 = 4 \text{ m} \quad D_S = 0.5 \text{ m} \quad D_0 = 10 \text{ m} \quad \text{NOM} = 1$$

$$\begin{aligned} \text{PAG} &= 20 \log D_1 - 20 \log D_2 + 20 \log D_0 - 20 \log D_S - 10 \log \text{NOM} - 6 \\ \text{PAG} &= (20 \log 5.5) - (20 \log 4) + (20 \log 10) - (20 \log 0.5) - 10 \log 1 - 6 \\ \text{PAG} &= 14.8 - 12 + 20 - (-6.0) - 0 - 6 \\ \text{PAG} &= \underline{22.8 \text{ dB}} \end{aligned} \quad (\text{NAG} = 20 \log 10/1 = 20 \text{ dB})$$

System will work: PAG > NAG

In particular, the logarithmic relationship means that to make a 6dB change in the value of PAG the corresponding distance must be doubled or halved. For example, if a microphone is 1 ft. from an instrument, moving it to 2 ft. away will decrease the gain-before-feedback by 6dB while moving it to 4 ft. away will decrease it by 12dB. On the other hand, moving it to 6 in. away increases gain-before-feedback by 6dB while moving it to only 3 in. away will increase it by 12dB. This is why the single most significant factor in maximizing gain-before-feedback is to place the microphone as close as practical to the sound source.

The NOM term in the PAG equation reflects the fact that gain-before-feedback decreases by 3dB every time the number of open (active) microphones doubles. For example, if a system has a PAG of 20dB with a single microphone, adding a second microphone will decrease PAG to 17dB and adding a third and fourth mic will decrease PAG to 14dB. This is why the number of microphones should be kept to a minimum and why unused microphones should be turned off or attenuated. Essentially, the gain-before-feedback of a sound system can be evaluated strictly on the relative location of sources, microphones, loudspeakers, and audience, as well as the number of microphones, but without regard to the actual type of component. Though quite simple, the results are very useful as a best case estimate.

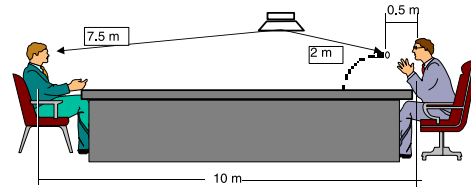

$$D_1 = 2 \quad D_2 = 7.5 \quad D_S = 0.5 \quad D_0 = 10 \quad \text{NOM} = 1$$

$$\begin{aligned} \text{PAG} &= 20 \log D_1 - 20 \log D_2 + 20 \log D_0 - 20 \log D_S - 10 \log \text{NOM} - 6 \\ \text{PAG} &= (20 \log 2) - (20 \log 7.5) + (20 \log 10) - (20 \log 0.5) - 10 \log 1 - 6 \\ \text{PAG} &= 6 - 17.5 + 20 - 0 - 6 \\ \text{PAG} &= \underline{2.5 \text{ dB}} \end{aligned} \quad (\text{NAG} = 20 \log 10/1 = 20 \text{ dB})$$

System will not work: PAG < NAG

APPENDIX THREE: STEREO MICROPHONE TECHNIQUES

An exception to the minimum-number-of-microphones rule is stereo sound pickup: at least two microphone elements are needed to pick up true stereo.



Example of stereo pick up technique using two cardioid microphones

These may be in the form of either separate standard microphones, or a single stereo microphone, combining the elements in one housing. In either case, the object of stereo application is to add the aspects of width and depth to the reproduced sound. This results in a more realistic image when heard through a stereo sound system. There are many techniques used to accomplish this goal, but they may all be categorized as follows: coincident, near-coincident, or spaced.

Coincident techniques use directional microphones, with the elements placed as close together as possible, but angled apart. The stereo image is a function only of the directional patterns of the microphones and the relative angle between them. This generally yields a stereo effect with modest “width” but good “localization” of sound sources. Single-housing/multi-element stereo microphones are also coincident types. They may contain unidirectional elements, bidirectional elements, or some combination of the two. Some of these, such as the M-S (Mid-Side) design, are capable of excellent (and sometimes variable) stereo width.

Since there is very little distance between coincident microphones, there is essentially no delay between the sounds picked up by them. This eliminates any potential interference (comb filtering) if the signals are combined for a monophonic sound system.

Coincident techniques are thus monocompatible.

Near-coincident techniques also use unidirectional microphones, but they are placed with their elements 6 to 12 inches apart, and at some angle relative to each other. In this method, the stereo image is a function not only of directionality but also of distance. The result is good image width and accurate image localization. Since there is a finite distance between the microphones, and hence, some delay between the sounds picked up, there may be some noticeable interference effects if the signals are combined monophonically.

Spaced techniques may use unidirectional or omnidirectional microphones. They are placed 3 to 10 feet apart and may or may not be angled relative to each other. Here, the stereo image is primarily a function of the distance between the microphones, and not their directionality. This technique results in exaggerated stereo separation and somewhat indistinct imaging, and is primarily used to pick up the ambient sound of a space. Due to the large distance between microphones, severe interference effects may result when combining direct sounds in mono.

STEREO PICKUP SYSTEMS	MICROPHONE TYPES	MICROPHONE POSITIONS	
X-Y	2 - CARDIOID	AXES OF MAXIMUM RESPONSE AT 135° SPACING; COINCIDENT	
ORTF (FRENCH BROADCASTING ORGANIZATION)	2 - CARDIOID	AXES OF MAXIMUM RESPONSE AT 110° SPACING; NEAR-COINCIDENT (7 IN.)	
NCS (DUTCH BROADCASTING FOUNDATION)	2 - CARDIOID	AXES OF MAXIMUM RESPONSE AT 90° SPACING; NEAR-COINCIDENT (12 IN.)	
STEREOSONIC	2 - BIDIRECTIONAL	AXES OF MAXIMUM RESPONSE AT 90° SPACING; COINCIDENT	
MS (MID-SIDE)	1 - CARDIOID 1 - DIRECTIONAL	CARDIOID FORWARD POINTED; DIRECTIONAL SHOT-POINTED; SPACING: COINCIDENT	
SPACED	2 - CARDIOID OR 2 - OMNIDIRECTIONAL	ANGLE AS DESIRED; SPACING: 3 TO 10 FT.	

Stereo Microphone Techniques

CONCLUSION

Though it is one of the smallest links in the audio chain, the microphone is one of the most important. Because it is the connection between sound and the sound system, it must interact efficiently with each. Choosing this link successfully requires knowledge of sound and sound systems, microphones, and the actual application. This presentation has included the basic principles not only of microphones but also of sound and sound systems. Through the examples given, the selection and use of microphones for a variety of worship facility sound requirements has been suggested. Applying these basic principles will assist in many additional situations.

The subject of microphone selection and application for sound systems is still an evolving topic, as new needs are found and as microphone designs develop to meet them. However, the basic principles of sound, sound systems, and the microphone that links them remain the same, and should prove useful for any future house of worship application.



BIBLIOGRAPHY

We've included a reading list for those of you who would like to learn more about the technical aspects of audio. The resources below are comprehensive, yet for the most part do not require that the reader have an extensive technical background.

Bartlett, Bruce

Introduction to Professional Recording Techniques. Howard W. Sams & Co., Indianapolis, IN
(Excellent recording reference, good microphone section)

Bore, Dr. -Ing. Gerhart

Microphones for Professional and Semi-professional Applications.
Gotham Audio Corporation (U.S. distributor), New York, NY
(More technical, very good dynamic/condenser comparison)

Burroughs, Lou

Microphones: Design and Application. Sagamore Publishing Co., Plainview, NY
(A classic, very readable)

Davis, Don, and Davis, Carolyn

Sound System Engineering. Howard W. Sams & Co., Indianapolis, IN
(Very detailed and comprehensive technical reference)

Davis, Gary D., and Jones, Ralph

Sound Reinforcement Handbook. Hal Leonard Publishing Co., Milwaukee, WI
(Complete and not overly technical)

Eargle, John

The Microphone Handbook. Elar Publishing Co., Plainview, NY
(Another classic, quite useful)

Eiche, Jon F., ed.

Guide to Sound Systems for Worship. Hal Leonard Publishing Co., Milwaukee, WI
(Based on Sound Reinforcement Handbook, excellent reference)

Huber, David Miles

Microphone Manual-Design and Application. Howard W. Sams & Co., Indianapolis, IN
(Thorough treatment, understandable)

BIOGRAPHY

Tim Vear

Tim is a native (and current resident) of Chicago. A lifelong interest in both entertainment and science has led to the field of audio as his choice for combining these interests in a useful way.

In the course of pursuing this goal, Tim has gained audio experience in both its technical and musical aspects. He has worked as an engineer for recording, radio and live sound, has operated his own recording studio and sound company, and continues playing music professionally. He earned a BS degree in Aeronautical and Astronautical Engineering, with a minor in Electrical Engineering, from the University of Illinois, Urbana-Champaign. While at the University, Tim also worked as chief technician with both the Speech and Hearing Science and Linguistics departments. He currently holds the position of Sr. Applications Engineer at Shure Brothers, Evanston, IL.

In his tenure at Shure, Tim has served in a technical support capacity for the sales, marketing and engineering departments. He has been active in product and applications training of Shure customers, dealers, and installers, as well as company staff.

One of his major objectives has been to increase awareness of quality audio, with particular emphasis on the contribution of proper microphone selection and technique. In this role, Tim has presented seminars for a variety of professional organizations including the Audio Engineering Society, the National Sound Contractors Association, and the Society of Broadcast Engineers. His articles have appeared in *Recording Engineer/Producer*, *Creator*, *Religion*, and other publications.

This book is dedicated to Lottie Morgan.

SHURE PRODUCT SELECTION CHARTS

MICROPHONES						
APPLICATION	MODEL	OPERATING PRINCIPLE	FREQUENCY RESPONSE	DIRECTIONALITY	ELECTRICAL OUTPUT	PHYSICAL DESIGN
Lectern	MX400 Series	Condenser	Shaped, vocal	Cardioid/Supercardioid	Bal. Low Imp.	Miniature gooseneck
	SM57	Dynamic	Shaped, vocal	Cardioid	Bal. Low Imp.	Full size
Altar	MX300 Series	Condenser	Flat	Cardioid/Supercardioid	Bal. Low Imp.	Boundary
Vocal	Beta 87A	Condenser	Shaped, vocal	Supercardioid	Bal. Low Imp.	Handheld
	Beta 58A	Dynamic	Shaped, vocal	Supercardioid	Bal. Low Imp.	Handheld
	SM87	Condenser	Shaped, vocal	Supercardioid	Bal. Low Imp.	Handheld
	SM58	Dynamic	Shaped, vocal	Cardioid	Bal. Low Imp.	Handheld
Headworn	SM10A	Dynamic	Shaped, vocal	Cardioid	Bal. Low Imp.	Headworn boom
Lavalier	MX183	Condenser	Shaped, vocal	Omni	Bal. Low Imp.	Miniature Lavalier
	MX184	Condenser	Shaped, vocal	Supercardioid	Bal. Low Imp.	Miniature Lavalier
	MX185	Condenser	Shaped, vocal	Cardioid	Bal. Low Imp.	Miniature Lavalier
	SM93	Condenser	Shaped, vocal	Omni	Bal. Low Imp.	Ultra-Miniature
	SM11	Dynamic	Shaped, vocal	Omni	Bal. Low Imp.	Small Lavalier
Choir	MX200 Series	Condenser	Shaped, vocal	Cardioid/Supercardioid	Bal. Low Imp.	Miniature overhead
	SM81	Condenser	Flat, variable	Cardioid	Bal. Low Imp.	Full size
	SM94	Condenser	Flat	Cardioid	Bal. Low Imp.	Full size
Congregation	MX200	Condenser	Shaped, vocal	Cardioid/Supercardioid	Bal. Low Imp.	Miniature overhead
	SM94	Condenser	Flat	Cardioid	Bal. Low Imp.	Full size
Acoustic Guitar	SM81	Condenser	Flat, variable	Cardioid	Bal. Low Imp.	Full size, stand mount
	SM94	Condenser	Flat	Cardioid	Bal. Low Imp.	Full size, stand mount
	Beta 57A	Dynamic	Shaped, inst.	Supercardioid	Bal. Low Imp.	Full size, stand mount
	SM11	Dynamic	Shaped, vocal	Omni	Bal. Low Imp.	Small, clip-on
Piano	SM81	Condenser	Flat, variable	Cardioid	Bal. Low Imp.	Full size
	SM94	Condenser	Flat	Cardioid	Bal. Low Imp.	Full size
Organ	SM81	Condenser	Flat, variable	Cardioid	Bal. Low Imp.	Full size
Stage	MX300 Series	Condenser	Shaped, vocal	Cardioid/Supercardioid	Bal. Low Imp.	Boundary, floor mount
	MX200 Series	Condenser	Shaped, vocal	Cardioid/Supercardioid	Bal. Low Imp.	Miniature overhead
Stereo	VP88	Condenser	Flat, variable	M-S Stereo	Bal. Low Imp.	Full size, stand mount
	SM81 (pair)	Condenser	Flat, variable	Cardioid	Bal. Low Imp.	Full size, stand mount

SHURE GUIDE TO
AUDIO SYSTEMS FOR
HOUSES OF WORSHIP

SHURE PRODUCT SELECTION CHARTS

WIRELESS MICROPHONE ELEMENTS													
Element	Design	Type	Response	Directionality	System Availability								
					T	T88	LX	LX88	VP	SC	UT	UC	UHF
WL93	Lavalier	Condenser	Shaped, vocal	Omnidirectional	x	x	x	x	x	x	x	x	x
WL183	Lavalier	Condenser	Shaped, vocal	Omnidirectional			x	x		x		x	x
WL184	Lavalier	Condenser	Shaped, vocal	Supercardioid			x	x		x	x	x	x
WL185	Lavalier	Condenser	Shaped, vocal	Cardioid			x	x		x	x	x	x
WH10	Headworn	Dynamic	Shaped, vocal	Cardioid	x		x	x		x	x	x	x
WCM16	Headworn	Condenser	Shaped, vocal	Hypercardioid			x	x		x		x	x
WM98	Instrument	Condenser	Flat	Cardioid			x			x		x	x
14A	Handheld	Dynamic	Shaped, vocal	Cardioid		x							
BG3.1	Handheld	Dynamic	Shaped, vocal	Cardioid	x						x		
SM58	Handheld	Dynamic	Shaped, vocal	Cardioid	x		x	x	x	x	x	x	x
SM87	Handheld	Condenser	Shaped, vocal	Supercardioid			x			x		x	x
Beta58A	Handheld	Dynamic	Shaped, vocal	Supercardioid			x			x		x	x
Beta87	Handheld	Condenser	Shaped, vocal	Supercardioid			x			x		x	x

WIRELESS MICROPHONE SYSTEMS					
System	Frequency band, Tuning capability	Transmitter: Style, battery	Receiver: Channels, operation, power	Available Frequencies	Maximum Compatible
T	VHF, fixed	Handheld or bodypack, 9V	Single, diversity or non-diversity, AC adapter	10	6
T88	VHF, fixed	Handheld or bodypack, 9V	Dual, non-diversity only, AC adapter	10	6
VP	VHF, fixed	Handheld or bodypack, 9V	Single, non-diversity only, 9V battery	8	6
LX	VHF, fixed	Handheld or bodypack, 9V	Single, diversity or non-diversity, AC adapter	28	10
LX88	VHF, fixed	Handheld or bodypack, 9V	Dual, non-diversity only, AC adapter	8	6
SC	VHF, 4 or 8 tunable	Handheld or bodypack, 9V	Single, diversity only, AC adapter	150	12
UT	UHF, fixed	Handheld or bodypack, 9V	Single, diversity only, AC adapter	8	8
UC	UHF, all tunable	Handheld or bodypack, 9V	Single, diversity only, AC adapter	100	16
U	UHF, all tunable	Handheld or bodypack, (2)AA	Single or dual, diversity only, AC internal	200	20

SIGNAL PROCESSORS							
Model	Functions	Channels	Inputs	Outputs	Computer Control		Power
					Platform	Port	
DFR11EQ4	Automatic Feedback Reduction 1/3 Octave Graphic Equalizer 10 Band Parametric Equalizer Low-cut and High-cut Filters 100 ms Delay	1	XLR & 1/4" TRS Balanced or unbalanced line	XLR & 1/4" TRS Balanced or unbalanced line	Windows PC	Serial	AC
DP11EQ	Automatic Gain Control Leveler Compressor Limiter Expander Gate No-Overshoot Peak Limiter 9 Band Parametric Equalizer 1.3s Delay	1	XLR & 1/4" TRS Balanced or unbalanced line	XLR & 1/4" TRS Balanced or unbalanced line	Windows PC	Serial	AC

SHURE PRODUCT SELECTION CHARTS

PERSONAL STEREO MONITOR SYSTEMS								
System	Description							
P6TRE1	UHF Wireless Personal Stereo Monitor System: P6T Transmitter, P6R Bodypack Receiver, E1 Earpieces							
P6HWE1	Hardwired Personal Stereo Monitor System: P6HW Hardwired Bodypack and Input Cable, E1 Earpieces							
Component	Band, tuning	Frequencies	Channels	Inputs	Outputs	Metering	Linking	Power
P6T transmitter	UHF, 2 fixed, switchable	10 (all compatible)	2 (stereo or dual mono)	XLR & 1/4" TRS Balanced or unbalanced line	1/antenna (BNC) 2/headphone (1/4" & 1/8" TRS)	2 LED strings	Loop-through (1/4" TRS)	AC
P6R receiver	UHF, 2 fixed, switchable	10 (all compatible)	2 (stereo or MixMode)	1/4 wave omni-directional antenna	1/headphone (1/8" TRS)	RF signal LED Power LED Low battery LED		9V battery
P6HW hard-wire bodypack			2 (stereo or MixMode)	5-pin Lemo Balanced or unbalanced line	1/headphone (1/8" TRS)	Peak LED Low battery LED Power LED		9V battery

AUTOMATIC MIXERS									
Model	Inputs: Number/level	Outputs: Number/level	Linking/ # of units	Metering	Lo-cut/ tone	Gating System	Microphones	Logic Functions	Power
SCM810	8/lo-z mic or line 2/aux	1/line 1/headphone	Link/50	Output LED string Input Active/Peak LED	Variable/ Hi-shelf	Intellimix Noise -adaptive MaxBus	Any dynamic or condenser	Mute, override priority, last mic lock-on NOMA	AC
AMS8100	8/lo-z mic or line 2/aux	1/line 1/headphone	Link/50	Output LED string Input Active/Peak LED	Variable/ Hi-shelf	AMS Directional MaxBus	AMS AMS22 AMS24 AMS26 AMS28	Mute, override priority, last mic lock-on NOMA	AC

STANDARD MIXERS										
Model	Inputs: Number/level	Outputs: Number/level	Linking/ # of units	Metering	Lo-cut/ tone	Phantom Vdc	Limiter	Tone Osc.	Power	
200	3/lo-z mic 1/lo-z or aux	1/lo-z mic, 1/aux							AC adapter	
M267	4/lo-z mic or line	1/line, 1/lo-z mic or line 1/headphone	Mixbus/2	Output VU, Peak LED	Switches	30	Switch	Switch	AC/battery	
M367	6/lo-z mic or line 1/monitor	1/line, 1/lo-z mic or line 2/headphone	Mixbus/2	Output VU, Peak LED Input Peak LED	Switches	12 or 48	Switches	Switch	AC/battery	
SCM262	1/lo-z mic 1/lo-z mic or line 3/stereo aux	1/stereo lo-z mic or line 1/stereo aux				12			AC	
SCM268	4/lo-z mic or aux 1/aux	1/lo-z mic or line 1/aux		Output LED string		12			AC	
SCM800	8/lo-z mic or line 2/aux	1/line 1/headphone	Link/4	Output LED string Input Peak LED	Variable/ Hi-shelf	48	Switches		AC	

The charts on pages 57 – 59 of this guide identify some of the Shure products most frequently used in Houses of Worship sound applications. To obtain further information on these products, or any of the free literature listed below, write to:

Shure Brothers Incorporated
Consumer Relations Department
222 Hartrey Avenue
Evanston, IL 60202-3696
Tel: 1-800-25-SHURE

- AL1350B — Microphone and Circuitry Products (Full Line) Catalog
- AL1204A — Introduction to Wireless Systems
- AL1247 — Selection and Operation of Wireless Microphone Systems
- AL1265 — Microphone Techniques for Music Studio Recording
- AL1266 — Microphone Techniques for Music Sound Reinforcement
- AL1267 — Guide to Audio Systems for Meeting Facilities
- AL969E — Guide to Audio Systems for Video Production

SHURE®

The Sound of Professionals...Worldwide®

Shure Brothers Incorporated
222 Hartrey Avenue, Evanston, Illinois U.S.A 60202-3696 • Phone: 800-25-SHURE Fax: 847-866-2279
In Europe, Phone: 49-7131-72140 Fax: 49-7131-721414
Outside of U.S. and Europe, Phone: 847-866-2200 Fax: 866-2585
www.shure.com